

# The Design of Dairy Cow and Replacement Heifer Housing

Report of the CIGR Section II Working Group N° 14  
Cattle Housing, 2014



*Commission Internationale du Génie Rural*  
*International Commission of Agricultural and Biosystems Engineering*

---

## Members of CIGR Section II Working Group N° 14, Cattle Housing

Josi FLABA, President  
Direction générale de l'Agriculture, des Ressources naturelles et de l'Environnement (DGARNE)  
Chaussée de Louvain 14  
B5000 NAMUR, Belgium

Heiko GEORG  
Institut für Ökologischen Landbau, Johann Heinrich von Thünen Institut  
Trenthorst 32  
D-23847 WESTERAU, Germany

Robert E. GRAVES  
The Pennsylvania State University  
Department of Agricultural and Biological Engineering  
201 Agricultural Engineering Building  
University Park - PA 16802-1909, USA

Joop LENSINK  
Groupe ISA Lille, Agricultural Department  
48, Boulevard Vauban  
F59046 LILLE cedex, France

Jim LOYNES  
Engineering Department, Harper Adams University  
NEWPORT, Shropshire, England, TF10 8NB

Elfriede OFNER-SCHRÖCK  
Lehr- und Forschungszentrum für Landwirtschaft (HBLFA)  
Agricultural Research & Education Centre Raumberg-Gumpenstein (AREC)  
A8952 IRDNING, Austria

Tom RYAN  
Teagasc, Kildalton College  
PILTOWN, Co Kilkenny, Ireland

Ludo VAN CAENEGEM  
Agroscope Reckenholz-Tänikon, Research Station ART  
CH-8356 ETTENHAUSEN, Switzerland

Michael VENTORP  
Swedish University of Agricultural Sciences  
P.O. Box 108, S - 230 53 ALNARP, Sweden

Paolo ZAPPAVIGNA  
DISTAL - Department of Agricultural and Food Sciences, University of Bologna  
Viale G. Fanin 50, 40127 BOLOGNA42100 REGGIO EMILIA, Italy

**Acknowledgements.** The authors also wish to recognise and thank the following for their input: W. Bickert (USA), J. Capdeville (France), R. Kaufmann (Switzerland), JJ. Lenehan (Ireland), M. Tillie (France) and many other persons for their valuable contribution. Special thanks go to O. Stassin for his assistance with the final layout.

© CIGR Section II working group No 14 Cattle housing

ISBN 978-2-9552352-0-1

## Table of content

1. Foreword.....	2
2. Fundamentals .....	3
2.1 BODY DIMENSIONS.....	3
2.1.1 BASIC LINEAR DIMENSIONS .....	3
2.1.2 CIGR STANDARDS ANIMAL DIMENSIONS .....	3
2.1.3 RELATIONSHIP BETWEEN LINEAR BODY DIMENSION AND BODY WEIGHT.....	3
2.2 DESIGNING FACILITIES TO MEET ANIMAL NEEDS .....	4
2.2.1 BASIC ANIMAL NEEDS AND REQUIREMENTS .....	4
2.2.2 ANIMAL HEALTH .....	5
2.2.3 CATTLE BEHAVIOUR .....	6
2.2.4 ENVIRONMENT AND HEALTH .....	8
2.2.5 THE STOCKPERSON .....	8
2.3 ENVIRONMENTAL REQUIREMENTS .....	9
2.3.1 INTRODUCTION.....	9
2.3.2 AIR TEMPERATURE .....	9
2.3.3 AIR RELATIVE HUMIDITY .....	9
2.3.4 RADIANT TEMPERATURE .....	9
2.3.5 AIR VELOCITY .....	10
2.3.6 COMBINED PARAMETERS.....	10
2.3.7 AIR QUALITY .....	11
2.3.8 LIGHT.....	11
2.3.9 NOISE.....	11
2.4 SUSTAINABILITY AND PRODUCTION SYSTEMS .....	12
2.4.1 GENERAL DEFINITION .....	12
2.4.2 SUSTAINABILITY AND AGRICULTURAL BUILDINGS - PRACTICAL ASPECTS WHEN CONSTRUCTING A DAIRY BUILDING .....	12
2.4.3 SOCIO-ECONOMIC ASPECTS, ANIMAL WELFARE AND HEALTH .....	13
2.4.4 APPROACHES TO SUSTAINABLE PRODUCTION SYSTEMS .....	13
3. Aspects of design .....	14
3.1 LOOSE HOUSING SYSTEMS .....	14
3.1.1 INTRODUCTION.....	14
3.1.2 CUBICLE SYSTEMS (FREESTALL) .....	15
3.1.3 STRAW YARD SYSTEMS .....	18
3.1.4 ADVANTAGES AND DISADVANTAGES OF THE LOOSE HOUSING .....	21
3.2 TIED HOUSING.....	22
3.2.1 INTRODUCTION.....	22
3.2.2 DIMENSIONS OF TIE STALL ARRANGEMENTS.....	22
3.2.3 STALL FLOORS AND BEDDING .....	23
3.2.4 THE SYSTEMS AND FACILITIES FOR RESTRAINING THE ANIMALS .....	23
3.2.5 CALVING AND NURSING BOXES .....	24
3.2.6 WATERING .....	24
3.2.7 COW TRAINERS .....	24
3.3 FEEDERS.....	24
3.3.1 INTRODUCTION.....	24
3.3.2 NUMBERS OF FEEDING PLACES .....	24
3.3.3 GENERAL DIMENSIONS.....	25
3.3.4 FEEDING BARRIER DESIGN .....	25
3.3.5 DEVICES FOR MOVING THE FEED.....	26
3.3.6 HAY RACKS .....	27
3.3.7 BALE FEEDERS .....	27
3.3.8 CONCENTRATE FEEDERS.....	27
3.4 DRINKERS .....	28
3.4.1 INTRODUCTION.....	28
3.4.2 DRINKING WATER REQUIREMENTS .....	28
3.4.3 POSITION OF THE HEAD AND COW BEHAVIOUR .....	28
3.4.4 WATER QUALITY.....	29
3.4.5 DRINKING FACILITIES - GENERAL REQUIREMENTS.....	29
3.4.6 FREEZING.....	29
3.4.7 ACCESS/LOCATION OF DRINKERS.....	30
3.4.8 NUMBER OF BOWLS/DRINKERS .....	30
3.4.9 TECHNICAL SPECIFICATIONS .....	30
3.5 FLOORING.....	31
3.5.1 INTRODUCTION.....	31
3.5.2 FLOORING SYSTEMS .....	31
3.5.3 STRUCTURAL REQUIREMENTS .....	31
3.5.4 ANIMAL FLOOR INTERFACE.....	31

3.5.5 FLOOR MATERIALS AND FLOOR TYPES .....	33
3.6 MILKING FACILITIES .....	35
3.6.1 INTRODUCTION .....	35
3.6.2 ELEMENTS OF A MILKING FACILITY .....	35
3.6.3 MILKING PARLOURS.....	36
3.6.4 DESIGN OF PARLOUR SURROUNDINGS .....	37
3.6.5 PARLOUR ENTRANCE AND EXIT: COLLECTING YARDS.....	38
3.6.6 OTHER AREAS.....	38
3.6.7 SPECIAL REQUIREMENTS OF AN AUTOMATIC MILKING SYSTEM (AMS) .....	39
3.7 CLIMATE CONTROL .....	40
3.7.1 GENERAL.....	40
3.7.2 VENTILATION .....	40
3.7.3 REDUCING HEAT STRESS .....	44
3.8 FACILITIES FOR CALVES AND REPLACEMENT HEIFERS .....	45
3.8.1 INTRODUCTION .....	45
3.8.2 HOUSING SYSTEMS FOR CALVES.....	45
3.8.3. FEEDING FACILITIES .....	47
3.8.4 VENTILATION .....	47
3.8.5 HOUSING SYSTEMS FOR REPLACEMENT HEIFERS.....	47
3.9. SPACE FOR ANIMAL CIRCULATION .....	49
3.9.1. PASSAGEWAYS .....	49
3.9.2 PASSAGEWAY FENCE AND WALL HEIGHT.....	49
3.9.3 PASSAGEWAY WIDTH .....	50
3.9.4 DOORS .....	51
3.10 SPECIAL NEEDS FACILITIES AND ANIMAL HANDLING .....	52
3.10.1 INTRODUCTION .....	52
3.10.2 LOCATION.....	52
3.10.3 HOLDING PENS .....	52
3.10.4 HOUSING OF TRANSITION COWS.....	52
3.10.5 CLOSE-UP AND CALVING PENS .....	52
3.10.6 TREATMENT AND HANDLING FACILITIES.....	54
3.10.7 FACILITIES FOR OTHER SPECIAL DAIRY COWS.....	55
3.11 HUMAN/WORKERS SAFETY AND HEALTH .....	55
3.11.1 INTRODUCTION .....	55
3.11.2 ANIMAL HANDLING .....	56
3.11.3 MOVEMENT OF CATTLE.....	56
3.11.4 MILKING .....	56
3.11.5 INSPECTION AND TREATMENT OF STOCK.....	57
3.11.6 HOUSING ENVIRONMENT .....	57
3.11.7 ANCILLARY ACTIVITIES.....	58
REFERENCES AND FURTHER READING .....	59



## 1. Foreword

The definition of dairy cow housing characteristics requires the understanding and knowledge of various interrelated subjects such as: ethology, animal husbandry, handling of the animals, optimization of the working conditions, protection of the people against accidents, ventilation of livestock buildings, properties of materials, landscape integration, manure management, etc.

This means that, in the majority of the cases, competences of several specialists must be combined to produce a design solution that, as far as possible, approaches the ideal and satisfies the farmers dream, whether it is the design of a new building to house their animals that are in full lactation, in a dry period or in a period of rearing. The overall cost of the project must also be taken into account, because it has an impact on the production cost of the milk produced.

Fortunately, scientific literature and knowledge is continually being added to by the results of research work devoted to one or more of the aspects evoked above. This allows the designer of livestock buildings to have access to multiple, varied and invaluable sources of information, which they then include in each step of the design process. The challenge is then to integrate all this information into the project and produce a coherent design with which both the user and the designer can be pleased.

This document, which has been compiled by the “Cattle Housing” working group of the International Commission of Agricultural and Biosystems Engineering (CIGR) has, hopefully, combined the many scientific data and the range of expertise of its members in many aspects of cattle housing. It is the result of an enthusiastic and profitable collaboration that has been spread out over several years. Indeed, the group has included specialists originating from 10 countries across Europe and North America, who have invested a considerable amount of time and effort to produce a document which they hope will be useful to all those involved in the design of cattle housing (designers, farmers, manufacturers etc.). They also hope that it will contribute to place dairy cows in excellent housing conditions and that it will help to increase the sustainable character of the dairy sector.

It was, for me, a privilege to chair, as well as take part in, the work of the working group and I thank each member for their devotion to duty and the enthusiasm they have shown throughout the process. I would also like to thank all those behind the scenes who have, in one way or another, also contributed to the realization of this report.

Josi FLABA

## 2. Fundamentals

### 2.1 BODY DIMENSIONS

#### 2.1.1 BASIC LINEAR DIMENSIONS

Knowledge of the basic dimensions of animals and the space they require to perform basic behaviours, e.g. lying, feeding or walking, is fundamental to the design of cow housing. Farmers seldom measure their animals before making decisions about housing. If successful housing solutions are to evolve, then farmers should be encouraged to make at least the basic measurements as outlined in Fig 2.1.1.1 or be guided by standard design figures, where:

- H - Height at withers
- L - Diagonal body length
- W - Width of chest

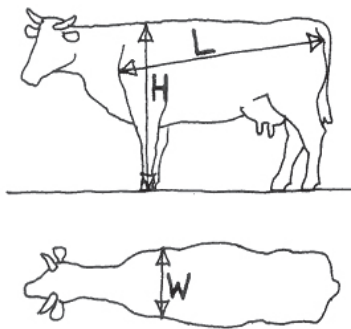

Figure 2.1.1.1: body dimensions of cows.

#### 2.1.2 CIGR STANDARDS ANIMAL DIMENSIONS

Table 2.1.2.1 “CIGR-Standard” is an overview of existing-animal dimensions of heifers and cows that can be adapted for practical design work, in the absence of more precise knowledge of the size of animals to be housed. These “CIGR-Standard” dimensions are especially suitable for Holstein Friesian cows.

Table 2.1.2.1: “CIGR-Standard”: dimensions of calves, heifers and cows (for Holstein Friesian) The dimensions refer to the average size within the weight interval

Category of animals	Weight (kg)	H (m)	L (m)	W (m)	Age (month)
Calves	100	0.9	0.84	0.27	3-4
	200	1.09	1.17	0.35	5-6
Heifers	150-249	1.09	1.17	0.35	4-7
	250-349	1.19	1.31	0.42	8-11
	350-449	1.27	1.42	0.47	12-15
	450-549	1.33	1.51	0.52	16-20
	> 550	1.38	1.59	0.55	21-24
Dairy cows	550-649	1.40	1.69	0.55	> 24
	650-749	1.44	1.75	0.60	> 24
	750-850	1.48	1.80	0.64	> 24

#### 2.1.3 RELATIONSHIP BETWEEN LINEAR BODY DIMENSION AND BODY WEIGHT

An animal’s live-weight (mass) and age are often well known and are commonly used for making judgements about its space requirements. This procedure is not accurate enough for good design practice, unless there are clearly established relationships between weight and body dimensions. These relationships vary widely between different breeds and even between individual animals of the same breed. Tables 2.1.3.1 and 2.1.3.2 illustrate the range of variation that can occur.

Table 2.1.3.1: dimensions of Simmental (Fleckvieh) cows in Austria (Jauschnegg, 1994). Values shown are mean values (average) together with the minimum and maximum values

Weight (kg)	H (m)			L (m)			W (m)		
	Min.	Average	Max.	Min.	Average	Max.	Min.	Average	Max.
500	1.20	1.27	1.35	1.37	1.48	1.60	0.38	0.46	0.54
600	1.26	1.33	1.40	1.46	1.57	1.67	0.44	0.52	0.60
700	1.30	1.37	1.43	1.52	1.62	1.73	0.50	0.57	0.65
800	1.32	1.38	1.45	1.54	1.62	1.73	0.54	0.62	0.70

Table 2.1.3.2: dimensions of cows of various breeds in Austria at 650 kg (Jauschnegg, 1994). Mean values (average) together with minimum and maximum values

Breed (cows at 650 kg)	H (m)			L (m)			W (m)		
	Min.	Average	Max.	Min.	Average	Max.	Min.	Average	Max.
Simmental (Fleckvieh)	1.28	1.35	1.42	1.49	1.60	1.71	0.47	0.55	0.63
Brown Swiss	1.29	1.37	1.46	1.54	1.63	1.72	0.46	0.52	0.58
Holstein Friesian	1.31	1.39	1.48	1.59	1.68	1.78	0.45	0.51	0.57

In “Aspects of Design” (Chapter 3) the width, length and area of the space required by an animal are expressed as functions of the dimensions H, L and W, as defined above. This method is adopted in an attempt to ensure that space provided in the housing design is more closely related to the actual size of animals to be accommodated.

In practice, in the absence of actual dimensions, the designer will need to make subjective judgements about the size of the cows to be housed. To this end Tables: 2.1.2.1, 2.1.3.1 and 2.1.3.2 give guidance. For safety and to accommodate the general increase in the size of cows (for example, sizes that may be associated with breed improvement) one should base designs on the dimensions of the larger animals in the herd or in the group.

## 2.2 DESIGNING FACILITIES TO MEET ANIMAL NEEDS

### 2.2.1 BASIC ANIMAL NEEDS AND REQUIREMENTS

In the 1960’s, discussions about animal welfare led to the basic rights for animals being established (Brambell, 1965). Certain basic physical needs in relation to housing were recognised. These were the right of an animal to have sufficient freedom of movement to allow it to get up, lie down, groom normally, turn around, and stretch its limbs, without difficulty.

Since then research has been done to clarify behavioural needs or goals. Works of relevance to the achievement of behavioural goals, which are important for the animal deserve special mention. Animal motivation and the functional consequences of behavioural processes are an important issue for a designer of facilities as they may affect animal welfare.

At present, it is generally agreed that the basic requirements for welfare of livestock are:

1. the provision of readily accessible fresh water and nutritionally adequate food as required;
2. adequate freedom of movement to express normal behaviour;
3. freedom from fear and distress;
4. social contact with herd mates;
5. freedom from discomfort, pain, injury and disease;
6. sufficient light;
7. complexity and change in their environment to avoid boredom; and
8. avoidance of unnecessary mutilation.

#### Motivation

The cow is strongly motivated to rest, feed, drink and move around. However, the need for an animal to carry out a cer-

tain behaviour at a certain time is still not clear. An animal always tries to proceed from the present situation (existing value) to the goal (required value). Only when the goal can be reached, the behaviour will end in an appropriate way and welfare will be assured.

#### Functional consequences

When an animal is motivated, it will perform one or more behavioural patterns. According to the Hughes & Duncan (1988) model of foraging behaviour, proper functional consequences are the main reason for an animal ceasing the behaviour. Therefore, creating opportunities for appetite behaviour alone (one part of the total foraging process) is not enough. This simply strengthens the animal’s motivation but does not allow the animal to achieve satisfaction. Even the presence of the means to achieve a behavioural goal is not always enough since providing a food supply for even a short duration will also strengthen motivation. Only completing the whole cycle leads to a longer term decrease of motivation.

#### Predictability and controllability

The predictability and controllability of environmental conditions should be included in any discussion about behavioural needs. They are of crucial importance in evaluating stress. Control of environment factors e.g. those influencing social interactions and feeding times, should be optimal. The predictability of response to certain behaviour should be monitored and reviewed regularly so that frustration and competition in the stock is kept to a minimum

#### Social contacts

Cows are gregarious animals living in groups. Each animal needs physical and visual contacts with other members of her species to exhibit normal behaviour.

Cows that are familiar with other cows come close together and groom and lick each other. They lie down close together and may stay together in the same part of the building for long periods of time. Cows that are close to calving will, preferably, be isolated from the herd to give birth in a loose housing pen with plenty of litter e.g. straw, wood shaving, sand. When the cow is in the separate pen, she should ideally maintain visual contact with herd members otherwise she may be stressed (e.g. agitated, bellowing) and this may lead to calving problems.

For socially gregarious animals like cows, daily routine is important to their behaviour and to reduce competition between animals. Daily routine is different according to the management situation that the animals are in: e.g. on pasture, in a building or in a building with an automatic milking system (AMS) (sometimes called a voluntary milking sys-

tem - VMS). On pasture the animals are exhibiting the same behaviour all together: grazing, resting, drinking, etc. In a building, the routine is dependent for the largest part on the times of milking and feed distribution. In a building with AMS, the milking is spread around the clock and the routine of activities is less regular. Each cow has her own rhythm.

## Stress

Intelligent animals need a complex and changing environment just as much as they need predictability and controllability. Besides ethological and physiological disturbances, excessive stress can also have negative effects on the animal's immune system and make animals more sensitive to infectious disease. However, boredom (lack of environmental stimulation) can be just as harmful as too much stress.

Housing submissive animals in a building with insufficient space can create a chronic stress situation because they fear close contacts with dominant animals and may experience severe aggression from their herd mates.

The climatic environment can cause stress since animals may have difficulties maintaining their body temperature, particularly when their environment is at a very high or very low temperature.

### 2.2.2 ANIMAL HEALTH

In many cases, concern about welfare is largely about the physical health of the animals and the economic consequences of their health. However, even if consideration is confined to the very limited issue of keeping the animals free from costly diseases, the situation will be far from simple. Disease is generally multifactorial and housing is only one of many factors involved. Furthermore, housing cannot be considered as a single factor, since a housing system can comprise a number of different designs and might include or exclude details that influence the incidence of a certain disease. What can be done is to find out how some detail is involved in the disease, e.g. how does the length of a stall or the area of the straw yard per animal affect contamination of the lying area and how does such contamination influence the incidence of mastitis. Even with such information one must be careful since a different stall design might well have features that would alter the desired length, or the incidence of mastitis might rely more on other factors (e.g. immune status, productivity, milking equipment or feeding) than on contamination of the lying area.

Consequently, predicting the consequence of all the details combined in any one housing system can only be speculative.

In unnaturally dense populations of housed farm animals, the risk of infection will be high. To some extent, this elevated risk can be counteracted by an increase in activity of the animals' immune systems. It is a question of getting the balance right. What is required is a level of infection that allows animals to develop immunity to disease, but not such a high level that it causes disease in animals with immunity. Non-infectious contaminants, such as inert dust particles and ammonia gas, can also harm animals by causing damage to the respiratory defence mechanism. Such agents can make the animal less resistant to infection and allergies.

In dairy production, with high yielding cows, the facultative pathogens normally living in the air and suspected of causing respiratory diseases become dangerous only if they find

favourable conditions such as animal overcrowding, high air humidity, air with too many dust particles, excessive air movements (draughts) or excessively high air temperature. To prevent diseases, it is advisable to limit the number of facultative pathogens living in the air because it is not possible to destroy them completely. Good ventilation and appropriate animal occupation density are two important measures to help prevent respiratory diseases.

To prevent the spread of infection within the herd it is recommended to isolate ill animals as soon as possible and to have enough room or pens for them. The cohabitation of animals of various ages and the bringing together of animals coming from different farms represent a situation with many risks. A quarantine practice (facilities and management) for purchased animals is advisable to diminish the risk of disease outbreak. Grouping of cows with regard to somatic cell count to avoid transmission of infections can be recommended.

Control of microbe populations and comfortable housing are the two important points that help preserve the health of a dairy cow.

Nowadays, a significant percentage of animals are affected by lameness, mastitis, reproduction disorders, metabolic disorders (e.g. milk fever, ketosis, etc.) that are responsible for poor cow longevity in many herds. The impact of these problems on the cost of producing milk is important and good house design and management have a role to play in minimising their effects.

Lameness in cattle is related to housing, feeding, breeding and management. Specific measures can reduce the prevalence of lameness; such as frequent floor scraping, regularly foot bathing and foot trimming, etc.

Mastitis is caused by pathogens living in the environment but housing may increase the pressure of infection. Inadequate cubicle dimensions, characteristics of partitions, lack of space in the resting area in loose housing, etc., may cause soiling of the resting area resulting in a negative impact on udder health. Poor air quality in a building and in the resting area, due to inadequate air openings providing insufficient ventilation, combined with high temperatures and humidity of the air, creates optimal conditions for the development of micro-organisms living in the environment. In addition, the functioning of the milking machine, and hygiene at milking, are also possible causes of mastitis.

Poor reproductive performance may have many causes: inadequate nutrition, poor heat detection, poor hygiene at calving and during artificial insemination, as well as slippery floors that affect heat behaviour.

Metabolic disorders may be caused by poor nutrition and inadequate feeding management. The building is rarely responsible for metabolic disorders but insufficient dimensions of passages that affect the movements of submissive animals and the time they stay eating at the feeding barrier may increase the frequency of metabolic disorders.

#### 2.2.2.1 Animal injuries

In loose housing three kinds of injuries are common: teat injuries, leg or claw injuries and skin injuries. Generally, teat injuries are caused by insufficient space for all cows to lie comfortably on bedded pack space or in cubicles and by poorly designed cubicle divisions (partitions) and other equipment.



Floors have to be designed to prevent leg and claw injuries and to cause sufficient wear to avoid overgrowth of the hoof. It is important to inspect cows' hooves regularly and to trim them when necessary. A foot bath can be used as one part of an effective means of treating and disinfecting cows' feet.

Other surface injuries result mainly from aggressive behaviour, often aggravated by too little space being provided for submissive cows to escape and inadequate equipment design, installation or maintenance. Emphasis on adequate dimensioning of all areas is therefore essential.

Furthermore, aggressive behaviour is very dependent on the quality of herd management, especially on the feeding regime and the competence of the stockperson.

The dehorning (where legally permissible) of animals decreases the consequences of aggressiveness and helps prevent animal injuries. Dehorning also diminishes the danger to stockpersons during animal handling. If animals are not dehorned, to prevent injuries, it may be necessary to adapt equipment, e.g. feeding barriers, and to increase the space of certain elements of the building, e.g. resting area's, passageways, etc.

### 2.2.2.2 Hygiene

Since dairy farms produce milk for human consumption the cows must be clean. Dirt on the cow can end up in the milk and dirty udders will lead to a higher incidence of mastitis. The udder is not the only part of the cow that should be kept clean. The cow will exhibit a behavioural need to keep clean by grooming and a wet, dirty coat will lose much of its insulating and protective properties.

Cleaning of dirty cows, particularly before milking, is laborious and can be ineffective. Consequently every effort should be made to prevent cows from becoming excessively dirty. It is most important to keep the lying area clean, which can be achieved by correct design, sufficient use of bedding material and regular management of the resting surface. Recommended maximum as well as minimum dimensions of cubicles and stalls should be specified and, for example, too wide a cubicle will be more easily soiled with dung. If animals are dirty, they will be uncomfortable and the development of ecto-parasites in their coat will be increased.

In loose housing, cows should have access to grooming brushes. In tied housing (where permitted) manual grooming is necessary.

Walking areas should also be kept reasonably dry and clean since any dirt picked up on the feet will be deposited on the lying area and will soil the cow. In addition, dirty hind legs may be in contact with the udder when the cow is lying down. Wet and dirty walking areas will also reduce the durability of the hoof horn and make the cow susceptible to foot diseases.

Tied housing systems, where allowed, generally require an increased labour input, when compared to cubicle housing, if it is to be maintained in a clean condition. In tied housing electric cow trainers, that gives a cow a shock if she arches her back to defecate or urinate onto the lying area, can help keep cows clean but may cause stress and has a negative effect on other aspects of cow welfare, including heat detection. In some countries electric cow trainers are for-

bidden. In this respect, new systems have been developed to improve both the cleanliness of cows and their comfort.

### 2.2.3 CATTLE BEHAVIOUR

Nowadays, it is not unusual to have groups of cows of about 200 animals living together in the same facility. In such large groups sub-groups may be formed for ease of management. In practice, group size depends on management factors such as herd supervision, milking and feeding. The formation, by the farmer, of smaller groups within a herd is usually based on factors such as milk yield (high/low yielders), dry cows, first calving cows, replacements, diet, date of calving, age of the cows and status of somatic cell count (mastitis) or other infectious diseases.

In many modern dairy units cows are kept indoors for most of the year. Therefore, it is important to ensure that, whatever housing system is provided, behavioural needs (e.g. resting, feeding, drinking and milking) are properly met.

#### 2.2.3.1 Resting

In loose housing systems cows often rest for between 10 and 14 hours per day spread out over 10 to 15 periods. Resting behaviour depends on various factors including times of feeding and milking, feeding frequency and management. Resting time is divided into lying time without sleep and lying time with sleep and total muscle relaxation. For the latter, the cow should be able to lie down with her head resting on and supported by the shoulder, so that the neck muscles can relax (Figure 2.2.3.1.1). To avoid disturbance and ensure suitable opportunities for resting, enough cubicles or space should be available for each cow.

To avoid competition in communal lying areas, there should be enough space for all cows to find a resting place and to lie down together. If cubicles are used there should be at least one cubicle for each cow. As a consequence of insufficient lying area there may be an increase in aggression and/or disturbances of behavioural rhythms (eating and resting times). In addition, cows that are unable to lie down will spend significantly longer time standing and will have an increased lying requirement when they do lie down.

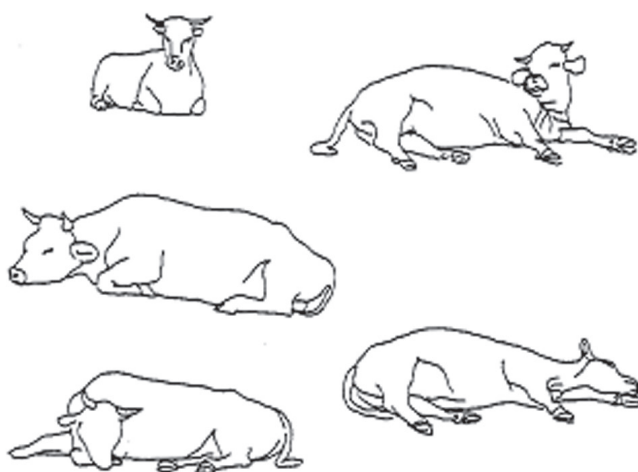

Figure 2.2.3.1.1: natural lying positions (according to Schnitzer, 1971).

Cows prefer to lie on soft material and resting areas should be sufficiently soft to allow good quality resting.

In cubicle systems the cubicle is an extremely important element of the cows' environment, affecting positively or negatively its comfort, cleanliness and health. Cubicles must be designed to ensure that they are comfortable for cows that are standing, lying down, changing from standing to lying, or lying to standing and to ensure that the cows remain clean and healthy during the housing period. Cubicles must be comfortable enough to encourage cows to use them mainly as a lying place for as long as possible (10 to 14 hours a day). The maintenance of the cubicle needs special attention to prevent dirty cows and mastitis. The use of adequate bedding material is important to keep the lying surface clean and comfortable and to prevent injuries that may arise if the lying surface is aggressive to the skin of the cows.

With AMS the cows are milked according to their own rhythm and a consequence of this is that the resting periods vary from cow to cow depending on when each cow decides to go for milking and/or feeding or drinking.

In tied housing systems the cows' movement and natural behaviour is restricted. Because many activities take place in the same area, the tie-stall will always be a compromise in order to meet different demands of the animal. There are several examples of conflicting interests: e.g. cows like to have a soft surface to lie on but prefer to stand on firm ground; or stalls must be short to prevent the cow from defecating on the bed but not so short that they disrupt lying behaviour. Any head restraint needs to allow for ease of rising and reclining, feed and water access, and comfortable resting.

#### Lying down and rising behaviour

The natural lying down behaviour begins when the animal sniffs at the ground while it slowly moves forward in search of a suitable place to lie down. When the cow has found a suitable place, it moves its head from one side to the other to examine the place. Then it bends its front legs, kneels and, finally, carefully moves one hind leg under its body and lies on it. The lying down behaviour requires enough space so that it can be carried out in a normal way. The head and body of a mature cow may thrust forward 0.6 - 0.7 metres during both the lying down and rising process, as a means of counter balancing the motion.

When the cow wants to get up in a natural way it firstly rises to its knees and then, at the same time as throwing its head forward raises the hind part of its body with its front leg knees functioning as a rocking point. This movement is one of the greatest physical activities of cattle. Natural lying down behaviour is the reverse of the movements of the natural rising behaviour, although animals often move their hind part slightly side wards inducing a more diagonal lying position.

Under unrestricted conditions, cows often carry out lying down and rising activities in one continuous movement. When cows are kept indoors their movements may be hampered by space shortage and/or hard and slippery flooring. Lying down and rising movements may be interrupted at different stages or the movements may be carried out abnormally. Where cows exhibit abnormal lying down/rising behaviour its frequency increases with age. Each lying down/rising procedure may last for several minutes instead of the usual 15 - 20 seconds and 5 - 6 seconds, respectively. At the same time there is a higher risk that the cow will injure herself. An example of abnormal lying down behaviour is where the cow bends one or both knees as she is about to

lie down, then stops and gets up again and stands on all four feet again. Another example of abnormal rising behaviour is where a cow tries to rise like a horse, i.e. not on her knees but with her front legs straight.

The natural getting up movements of cattle is shown, sequentially in Figure 2.2.3.1.2.



Figure 2.2.3.1.2: natural rising behaviour of cattle.

#### 2.2.3.2 Feeding

Cows spend 5 to 9 hours a day eating depending on their diet. Each feeding period (10-15 per day) lasts for approximately 30 to 45 minutes.

The feeding system should, therefore, be designed to avoid competition, frustration and aggression. The important factors are space per animal, feed availability, barrier design and time to access. Self locking barriers can avoid competition and are useful for animals' observation and treatment. Any restriction in the number of places may result in low-ranking animals receiving insufficient feed and as a consequence they produce less milk.

#### 2.2.3.3 Drinking

Cows drink up to 130 litres of water in 10 - 15 visits to the drinker each day (Castle and Thomas, 1975). The consumption of water depends on the dry matter percentage of the ration, the milk yield and the temperature of the environment (Figure 3.4.2.2).

#### 2.2.3.4 Locomotion

Floors should provide a sure footing for the cow to move around without fear of slipping or falling. Any slips that occur during, or as a result of confrontations, can bring the animals into a state of chronic stress. Slippery floors can also cause cows to reduce their movement, grooming activities and mounting activities. Slipping on floors is one of the main causes of lameness in dairy cattle. Movement difficulties can cause irregular hoof wear and lameness. Floors with good traction improve cow confidence whilst walking and will lead to more natural locomotion and behaviour.

#### 2.2.3.5 Stereotypical behaviour

The cow behaves in a way that can accommodate most situations that arise in nature. However, if cows encounter situations that they cannot resolve they may be adversely stressed. For example, if a cow stands beside a dominant and aggressive cow its natural response would be to walk away. However, if the cow is unable to do this, she might become very distressed.

Because of their lack of freedom to behave naturally, tied cows sometimes exhibit stereotypical behaviour, such as tongue-playing, bar biting and leaning. Even loose housed cows can exhibit stereotypical behaviour when faced with different stressful situations or if they are housed in poorly designed facilities.

### 2.2.4 ENVIRONMENT AND HEALTH

#### 2.2.4.1 Air quality and ventilation

In well ventilated buildings, by natural ventilation, the air is generally of good quality and is not the cause of respiratory diseases in adult cattle. In general, natural ventilation of buildings allows air quality to be maintained at a low economic cost.

In many livestock buildings, animals are densely stocked, floors may be covered with faeces and urine or under floor slatted tanks may hold stored slurry and there can be large quantities of dusty feed and bedding. As a consequence, the air in these heavily occupied buildings can be contaminated with inorganic dust, spores, moulds, bacterial and viral organisms, gases, vapours and other pollutants. Airborne particles may cause infections, allergies and other responses, while gases and vapours may be poisonous, asphyxiants or irritants. These aerial pollutants may be very small or invisible and may not smell and thus are difficult to detect. However, they are easily inhaled.

In cattle buildings, the most dramatic effect of poor air quality occurs with young calves during the first two months of life. Good calf management practice includes feeding new born calves good quality colostrum milk immediately after birth. This provides immunity while the calf grows and develops its own protection system. It is also important that young calves are not exposed to massive challenge of airborne infectious agents from older animals, especially during the first 2 months of life. This is the main reason why young calves and adult dairy cows should preferably not be housed in the same building for the first two months. Adult cows are more resistant and able to tolerate such aerial contaminants. However, while adult cows seldom exhibit clinical symptoms of respiratory disease, their production performance or general health status might be diminished. Little is known about such relationships, but it is clear that amongst people working for prolonged periods in intensive

animal buildings there is also a higher incidence of respiratory disease.

#### 2.2.4.2 Light

Illumination is important in housing, since animals need to see so they can behave normally, e.g. move, feed, or lie. It is also important for the stockpersons, so they can inspect and care for their animals.

The duration of light exposure has an effect on growth performances in heifers and on milk production of dairy cows. Heifers reach puberty earlier and obtain higher growth rates when exposed to a regime of 16 hours of daylight when compared to much shorter lengths of daylight (Tucker et al., 2008). Increased day lengths improve milk production in dairy cows. Especially during autumn and winter months (in the northern hemisphere), 16 hours light per day, obtained partially by artificial lighting, leads to an increase of milk production by 7% to 15% in comparison with no additional light (e.g. Reksen et al., 1999; Miller et al., 1999). Furthermore, after calving, exposing dairy cows to a longer period of light brings on oestrus earlier (Hansen, 1985). However, it is important to maintain a minimum period of darkness, with the optimum duration of darkness being 6 hours per day, needed to stimulate correct hormone cycles.

Next to the duration of light exposure, light intensity is important (see par. 2.3.8). Research in this area is still ongoing and recommendations might change in future. The area of controlled day length lighting is changing so up-to-date information should be obtained when developing designs and management practices for controlled lighting.

#### 2.2.4.3 Noise

Noise can have a negative impact on animal welfare (Waynert et al., 1999; Schäffer et al., 2001). Measures should be taken to avoid noises that can produce fear in animals (banging of self locking feeding barriers, doors, machinery, etc.) equally continual background noises (e.g. fans, heat exchangers, etc.) may have the same effect.

In milking parlours the level of noise must be as low as possible (milking machine, vacuum regulators, barriers, fans, radios, etc.) and the milker should not have to shout excessively to be heard.

### 2.2.5 THE STOCKPERSON

The welfare of cows will be influenced by the treatment they receive from the stockperson. It is important that the presence of humans does not cause fright or induce stress reactions. The good stockperson will adopt a caring, friendly and predictable attitude towards the animals.

The attitude of the stockperson and how the cows are handled is especially important during milking because he/she is in close contact with the cow. The time needed for a cow going from the collecting yard into the milking parlour is negatively influenced by the attitude of the stockperson. The number of defecations in the milking parlour goes up if the stockperson has an unfriendly attitude to the cows (Waiblinger et al., 2003). Finally the milk production goes down if milking is carried out by an unfriendly person. Facilities that are convenient and helpful for the stockperson to perform the necessary task and where they are properly trained can result in improved cow care and handling procedures.

While a high level of mechanisation will lessen the burden on the stockperson, it can be counter-productive. In highly mechanised housing systems, for example, the animals may not regard the stockperson as the one who brings the food but as the one who carries out veterinary treatments that sometimes are painful for them. In such situations it is important for the stockperson to find other ways in which her/his presence will elicit a positive response from the cows. Stockpersons involved in managing dairy herds require an aptitude and training to develop the necessary skills in the use of equipment and facilities to complete the job.

## 2.3 ENVIRONMENTAL REQUIREMENTS

### 2.3.1 INTRODUCTION

Dairy cows, like all living creatures, have a continuous exchange, in terms of energy and mass, with the surrounding environment. In this activity, the most important factors for production are those influencing the thermal exchange (sensible and latent heat) and respiration. Therefore, the main environmental parameters to be controlled, in order to optimise animal health and welfare and, consequently, production are: air temperature, air relative humidity, radiant temperature, air velocity, noxious gas concentration, dust concentration and micro-organism concentration. Other important environmental characters to be considered along with thermal exchange are light and noise (see also 2.2.4).

Many studies have been carried out to define the critical values of such parameters, but variability of the experimental conditions (animals and treatments) and the different animal response under test conditions compared to real farming, make it difficult to define scientifically rigorous thresholds. Therefore, it is more advisable, for our purposes, to make a reference to simple, although approximate, values of practical use.

### 2.3.2 AIR TEMPERATURE

When defining the suitable limits for air temperature we have to distinguish between the requirements of the animals and those of men and/or equipment. In fact the human response is not the same as that of the animals, especially in cold climates, where cows can tolerate much lower air temperatures than men.

For instance, dairy cows, especially the highly productive, can tolerate, when adequately fed and protected from draughts, very low temperatures (down to  $-20^{\circ}\text{C}$  or lower for Holstein cows) without a decrease in milk production (of course the feed efficiency worsens). Therefore, in a cold climate, it is most important to avoid excessive air movement around the animals. However, some operations (scrapping, flushing and especially milking) and some equipment (i.e. drinkers), together with stockman comfort and safety, require that the problem of freezing is given due consideration.

Opposite to this, in a warm climate, cows start reducing their milk production from about  $+21^{\circ}\text{C}$  upwards with a more significant effect from  $24^{\circ}\text{C}$ , resulting in a reduction of about 2.5% per degree up to  $27^{\circ}\text{C}$ , -3.5% between  $27^{\circ}\text{C}$  and  $29^{\circ}\text{C}$  and -5% over  $30^{\circ}\text{C}$ . The threshold value is however very dependent on milk yield. The more productive cows are the more sensitive to heat stress. In a hot climate, as it is practically impossible to keep the internal temperatures at the optimal level for production, the main goal is to keep the inside to outside temperature gradient as low as possible (when positive), whatever the temperature level. The

minimum night temperature is important in helping reduce any heat stress during the day. Another important factor is the duration of any exposure to high temperatures.

The animal housing system is also relevant. In a cold climate, loose housed cows can better adapt if they can lie down on a dry littered floor and have the possibility of grouping together and choosing the more protected sites. This is not possible for tied cows, which are therefore more susceptible to rapid temperature decreases and to draughts. Loose housed animals can better adapt in a hot climate by using shaded and well ventilated areas and will benefit from access to an external yard, when one exists, especially during the night.

### 2.3.3 AIR RELATIVE HUMIDITY

Air relative humidity (RH) influences thermal exchanges, but also more generally it influences the animals health and welfare. Cows can compensate for reduced capability in their ability to dissipate metabolic heat in a sensible way (i.e. when the air temperature approaches the skin temperature) by increasing heat dissipation in a latent way (i.e. through respiration and evapotranspiration). This ability is very helpful in a hot climate, and becomes the main method of heat dissipation where the temperature is over  $+25^{\circ}\text{C}$ . A high RH value will seriously restrict the evaporative heat loss if it is associated with a high temperature. RH has no practical influence when temperature remains below  $24^{\circ}\text{C}$ . Over this value, RH of 40% has significant influence on production (Figure 2.3.3.1).

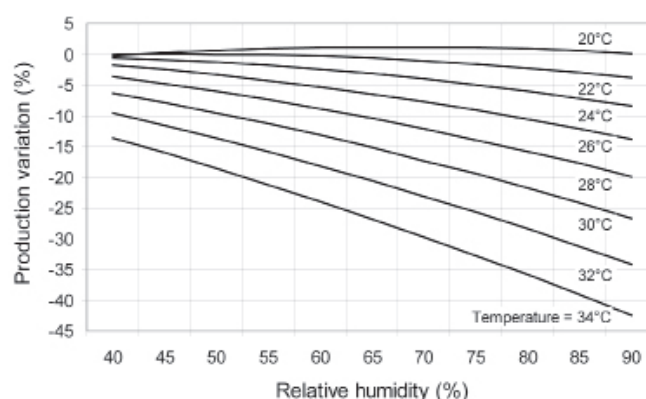

Figure 2.3.3.1: milk production variation (%) in relationship to air relative humidity (RH) and temperature, at an air speed of 0.5 m/s (Baeta et al., 1987).

Excessive air dryness can be dangerous as well. At RH values below 40% dust generation increases and mucous membranes of the upper respiratory tract will become dry. In a very hot and dry climate the risk of dehydration should be considered too. In cold climate, high relative humidity can have negative effects not only by increasing the heat loss, since the hair coat becomes wet and its insulating property is reduced, but also by favouring the transmission and multiplication of micro-organisms.

Furthermore, when the internal surfaces of the building (mainly the floors) are constantly wet, it increases the animals dirtiness and wetness. It may also result in deterioration of building construction. (For practical reference see Figure 2.3.6.1.1).

### 2.3.4 RADIANT TEMPERATURE

Next to air temperature, temperature of the surrounding surfaces can affect thermal behaviour of animals, as this influences any heat exchanged through radiation. The am-

bient temperature can therefore be better defined as a combination of the air temperature and the surface temperature of the building elements (generally the average of them). Heat exchange from a cow with the buildings surfaces, through radiation, largely depends on the difference in their surface temperature and the distance from the facing bodies. Therefore, it is important to prevent animals being too close to, or surrounded by, very cold or very hot building surfaces.

A similar effect can be produced on animals by solar radiation, both directly and indirectly, i.e. reflected by the sky and any other nearby or surrounding bodies. Direct solar radiation in hot climates can have severe consequences on animal production and welfare, and must be avoided wherever possible.

### 2.3.5 AIR VELOCITY

By moving air layers around an animals body convective heat transfer and evaporation rate can be increased. This action has a negative influence in cool conditions but a very positive effect in hot conditions. The effect is hard to quantify because it depends on many factors such as hair length, body mass, air temperature and so on. An increase of 1 m/s of air velocity at low temperatures may be equivalent to an air temperature decrease of 1.5°C to 2°C for animals with winter coat and between 3°C and 4°C for animals with summer coat. In hot conditions, the effect of air movement is less relevant, about 1°C for the same air velocity increase. The release of sensible heat tends to vanish as air temperature equals that of animal skin. However, in a hot climate (more than 25°C), increase in air velocity at animal level can increase heat dissipation in a latent form, independently of air temperature.

The effect of the air velocity is non linear. It tends to decrease as the limit of the body transpiration is nearly reached.

### 2.3.6 COMBINED PARAMETERS

#### 2.3.6.1 Air temperature and humidity

A combination of the parameters, air temperature and relative humidity, is generally considered to be a more effective approach to determining the appropriate environmental conditions for animal production.

A simple solution of this type can be expressed (Figure: 2.3.6.1.1) by an empirical determination in a Cartesian graph showing limits of similar animal productive response to the various possible combinations of the two parameters. (Only the productive losses referred to the high temperatures are based on scientific investigations; for the low temperatures the limits are an indication).

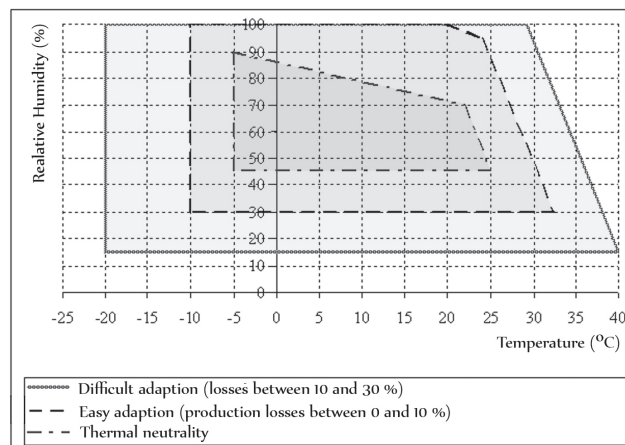

Figure 2.3.6.1.1: graph representing limits of similar animal productive response as a function of air temperature and relative humidity at an air speed of 0.5 m/s.

Another approach consists of using a unique indicator capable of estimating the combined effect of air temperature and humidity on heat stress. The most commonly used is the Temperature Humidity Index (THI) given by the formula:

$$THI = DBT + 0.36 DPT + 41.2$$

Where DBT is the dry bulb temperature (°C) and DPT is the dew point temperature (°C).

A more practical version is:

$$THI = (1.8 T + 32) - [(0.55 - 0.0055 RH) \times (1.8 T - 26.8)]$$

Where T is the air temperature (°C) and RH is the air relative humidity (%).

It gives a slight difference compared to the previous equation, but is still acceptable for practical purposes.

The upper critical limit varies between 69 and 75, but a value of 72 is commonly used. The decrease in milk production is generally estimated as 2% per unit over the critical threshold. The more productive cows are, the more sensitive they are to high values. Another effect of high THI-values is shown in Fig: 2.3.6.1.2.

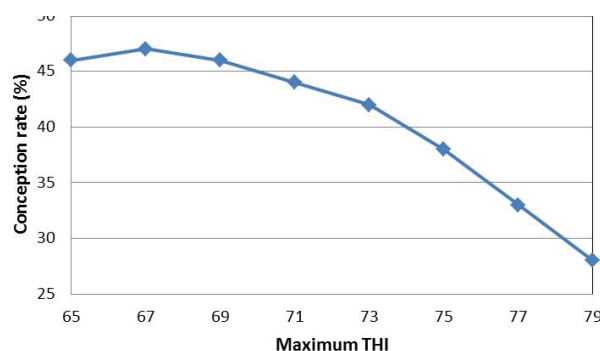

Figure 2.3.6.1.2: relationship between monthly average maximum temperature-humidity index (THI) and conception rate for 16,878 services performed in lactating dairy cows in Australia (after Morton et al. 2007).

### 2.3.6.2 Air temperature, humidity and velocity

The combination of air temperature, air relative humidity and air velocity is an adequate indicator of milk production losses induced by heat stress. Figure 2.3.6.2.1 shows the potential milk yield losses at different levels of air temperature and velocity when relative humidity is 60%. For example, at 30°C and 2.5 m/s the decrease of milk production is about 10%.

Among the physiological indicators, the respiratory rhythm has revealed to be a more immediate sign of heat stress, but the rectal temperature has generally been found to be more related to the productive variations.

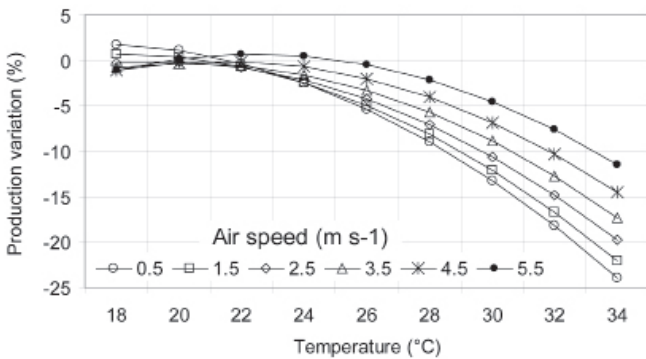

Figure 2.3.6.2.1: milk production variation in relation to air temperature and speed, at RH = 60% (after Baeta et al., 1987).

### 2.3.7 AIR QUALITY

The air in buildings that are heavily stocked can be contaminated with inorganic dust, spores, moulds, bacterial and viral organisms, gases, vapours and other pollutants.

The noxious gases that are found in the highest elevated concentration are ammonia, carbon dioxide and hydrogen sulphide. For those gases specific recommendations for maximum admitted concentrations are shown in the table below (adapted from CIGR 1984).

Table 2.3.7.1: recommendations for maximum gas concentration (CIGR 1984)

Gas	Max. concentration ppm
Carbon dioxide	3000
Ammonia	20*
Hydrogen sulphide	0.5
* in cowsheds 10 is preferably recommended	

To avoid a high gas concentration measures such as proper ventilation, frequent removal of slurry or good urine drainage characteristics of the floor etc. should be adopted. Dangerous situations may occur, especially when manure is agitated before and during the emptying of manure pits. In this situation, doors and windows should be kept open as much as possible; or the workers and the animals should be evacuated from the building.

Dust is often an ignored physical contaminant of the air but may be dangerous, not only for animals, but also for human. The smallest dust particles are the most dangerous. If

present in large quantities dust can cause irritation of the respiratory tract and mucous membranes and permanently damage the lung alveoli, as well as facilitate the spread of microorganisms. In general the concentration of dust in cow houses is not very high (acceptable optimum 0.5 to 1.0 mg/m<sup>3</sup>), especially in loose houses. Even so, at such concentrations the number of particles is still high (in the range of 10<sup>5</sup> to 10<sup>6</sup> particles per m<sup>3</sup>) and is therefore capable of carrying numerous bacteria and viruses. In cattle buildings a proper ventilation is again an important factor for risk reduction, but the most effective way to obtain a low dust concentration level is to prevent formation by using hygienically perfect forage and bedding material.

In housing for cows, air hygiene problems may be relatively easy to solve. Because cows can tolerate cold conditions, high ventilation rates can be applied to dilute and remove contaminated air from buildings. Designers must ensure that fixtures and equipment in the buildings can also tolerate cold or below freezing temperatures. For human safety requirements see par. 3.11.6.1.

### 2.3.8 LIGHT

The standards for illumination of cattle barns are generally based on achieving good working conditions for the stockman. Such illumination may be provided by artificial or natural light. Because natural light is suitable for animal welfare, it is often recommended to provide an area of translucent material in the roof or walls. A distinction should be made for the design of buildings in countries with high levels of solar radiation where animals are housed all the year. It is important to prevent solar radiation from over-heating the cow lying area in summer.

The duration of light exposure has an effect on growth performance of heifers and on milk production of dairy cows (see par. 2.2.4.2).

Light intensity is also important both for animals and humans (work quality and safety). The minimal light intensity for cattle at which they can still recognise objects (e.g. feed) is 5 lux. As cows might eat at night, this should be the recommended intensity. A sufficient light intensity to enable adequate observation of cattle is 120 lux, but a minimum of 150 lux is recommended. For the living area (resting, walking, etc.), the light intensity should ideally be between 150 and 200 lux during the day, while the levels for other parts of the building depend on the type of activity, which is being carried out there (see par. 3.11.6.3).

### 2.3.9 NOISE

Cattle are more sensitive to high frequency noises than humans. So measures should be taken to avoid those that can produce fear or stress in cows (self locking feeding barriers, gates, doors, equipments, machinery, etc.). Animals will be calmer and easier to handle if noise levels are reduced. Especially in the milking parlours the level of noises must be as low as possible (milking machine, barriers, fans, etc.) and the milker should avoid shouting or speaking too loudly. Clanging and banging metal parts should be silenced with rubber pads.

The limits for humans seem to be valid for cattle too. For the human a reduction of 10 dB is equivalent to a 50% perceived noise reduction. The noise level in cattle houses including the milking centre must not exceed 65 dB(A) continuously and 80 dB(A) for shorter exposure.

## 2.4 SUSTAINABILITY AND PRODUCTION SYSTEMS

### 2.4.1 GENERAL DEFINITION

In agriculture, just like any other industry, modern society requires production systems to be sustainable. Sustainability means different things to different people, but a frequently quoted definition is:

“Sustainable development is development that meets the needs of the present without compromising the ability of future generations to meet their own needs.” (WCED, 1987) Thus, the concept of sustainability encompasses economic, social, and ecological issues. It is intended to be a means of configuring civilization and human activity so that society and its members are able to meet their needs and express their greatest potential in the present, while preserving biodiversity and natural ecosystems, and planning and acting for the ability to maintain these ideals indefinitely. This inter-generational concept of sustainability is important and national and international legislation and policy agreements are providing a framework where sustainability can be realised on this long-term time framework.

### 2.4.2 SUSTAINABILITY AND AGRICULTURAL BUILDINGS - PRACTICAL ASPECTS WHEN CONSTRUCTING A DAIRY BUILDING

Even if aspects of sustainability regarding livestock buildings are rather complex, an attempt should be made to translate the definition of sustainability into terms of agricultural buildings. Within this context, three major fields can be identified: building materials and design, environmental aspects and socio-economic aspects including animal welfare and health.

#### 2.4.2.1 Building Materials and Design

##### *Recycling of building materials*

Problems with asbestos or partly with insulation materials indicate the importance of considering recycling and demolition of buildings even when you build a new one. Of course, no one will think of demolition (Fig. 2.4.2.1.1) when constructing a new dairy housing facility, but duration of use and technical innovations change much faster than decades before. Limited resources imply that even raw materials should be sorted out and recycled. Recycled concrete consist of 25 % granulated concrete material to replace gravel and thus reduces necessity of dumping concrete from demolished buildings. Mixed granulates of concrete, bricks and stones can be added to concrete as well and maybe used for pavement.

##### *Re-Use or Conversion of Farm Buildings*

New constructions should consider future change of building purposes. Depending on the height of truss and absence of additional frames at the feeding table, dairy houses can be used as storage facility, riding hall or industrial building in the future, if the farm is no longer economically efficient.

##### *Expandability*

Within the farm development plan, a new building should be constructed to be expanded easily in the future, even if it seems to be not necessary at present. This includes the site plan as well, especially in countries with limited farm land. For the building itself it is worth to think about “interfaces” of expansion. E.g. how to continue with truss, walls, alleys, as well position of manure pit joints.

##### *Lifecycle-Analysis:*

To assess impacts of buildings, lifecycle analysis may be



Figure 2.4.2.1.1: demolition of a cattle building: Mixture of old building materials has to be sorted due to contemporary environmental regulations.

established in the future according generally accepted rules (e.g. ISO) in order to compare ecological properties of buildings. This will include costs and ecological impacts and might be helpful to manage this complex topic sustainability.

#### 2.4.2.2 Environmental Impacts

A sustainable building strategy should consider “environment” as an entity. This includes emissions as well as resources and rural neighbourhood.

**Low emission rates** (gases, noise, odours, particles and germs): The design and construction of a dairy building can contribute to lower emissions. E.g. appropriate flooring may lead to lower ammonia emissions (chapter “Flooring”). Odours can be avoided when considering location and technical design of manure storage facilities. In some countries covering of storage tanks is mandatory because of environmental effects.

**Energy saving:** Energy saving concepts are a “must” and have been practiced in dairy farming for a long time. Dairy facilities can re-use energy from milk cooling to warm up (drinking) water or heat buildings. There are three main categories for energy saving technology: milk cooling systems, energy efficient motors, variable speed vacuum pumps and energy efficient lighting.

**Renewable energy production:** When constructing a new building, especially when herd size is “upscaled”, solar energy requirements should be considered in minimum as an option (orientation of building, slope of roof),

**Water resource management:** When constructing a new dairy building, attention should be paid to reduce contaminated water run-off. Concepts of separating rain water from clean surfaces apart from those of soiled areas can be implemented easily, if a new construction is planned. For instance switching between separate pipes for clean and contaminated water, if storage areas (roughage, solid manure) are clean and out of use for certain periods. It is much easier to install a second pipe before the building is finished. If possible, clean run-off water and greywater can be collected in a storage tank/basin to flush areas within the building for cleaning purposes.

**Other environmental impacts:** Rural neighbourhoods are more and more concerned about particulate matter from livestock housing. It is a good practice to involve neighbours in an early stage in the planning of a cattle building, if impacts can be expected. Impacts maybe not only gaseous emissions, but noise and odours as well as intensive lighting

of a building. In this context, special regard should be given to appearance and acceptance of the planned cattle building. Roofing, colours and materials play an important role and can easily be adapted during the phase of planning. This topic is not only related to the adaptation to the landscape, it means acceptance by the neighbourhood as well.

### 2.4.3 SOCIO-ECONOMIC ASPECTS, ANIMAL WELFARE AND HEALTH

In this section one should pay regard to support preventive animal health by designing cattle buildings to fulfil (or over-fulfil) animal needs. It is evident, that fresh air inside a dairy house is needed to prevent respiratory diseases, but in agricultural practice, compromises are more often visible than best practice. Information how to include animal health prevention can be found in each chapter of this report, flooring, climate, handling facilities, just to mention a few. One aspect besides that, which is not included, might be the need of cattle to be exposed to fresh air and sun as well as the need for grazing as a natural behaviour for ruminants. Farm label schemes like in Switzerland (RAUS) or production according organic farming rules consider those needs and provide animals with access to pasture and exercise yards. This may be health preventive, for example the exposure to sunlight (UV-radiation) stimulates vitamin D synthesis of dairy cows.

A good working environment for the stockpersons contributes to the “socio-economic welfare, work safety” of the human labour. Chapter worker safety explains the standards and requirements. Motivated stockpersons are more likely to handle animals well.

Monitoring tools like video and a stable office, which can be used as observation room, facilitate herd management and reduce costs.

### 2.4.4 APPROACHES TO SUSTAINABLE PRODUCTION SYSTEMS

#### 2.4.4.1 Label Schemes

Food Assurance Schemes: Many food assurance and labelling systems have been developed to inform the consumer about the type of production system used. These range from simple country of origin labels to labels guaranteeing specific quality attributes of the product, e.g. Label Rouge in France indicates a guaranteed level of superior quality. Such labels can encompass the goals of promoting sustainable production. However, the consumer is often influenced by strong retail brands that may not in fact encompass the principle of sustainable production as a primary concern.

Label production as special production systems are often connected with limitations of fertilizer and pesticides to reduce environmental impacts on ground water or other environmental systems like soil, air etc. An example for an environmental label was the Dutch “Green Label”, where parts of dairy cattle buildings like alleys should reduce ammonia emission by minimum 50 %.

#### 2.4.4.2 Organic Farming

The basic idea of organic farming is a sustainable food production within the farm cycle (EC directive of organic farming 889/2008). “Housing conditions should meet animal wel-

fare on a high level as a priority for organic livestock farming and may go beyond Community welfare standards...” The holistic approach of organic farming comprises land related livestock production, preventive animal health management and low external input like soya. Starting as a niche production system in several countries, organic became more and more important within the last decade. Consumer demand pushed the development of organic farming, especially when credibility of conventional livestock production was in a crisis (BSE, FMD). In several European countries organic farming schemes were established to support research and organic farming topics. “The organic sector amounts to an estimated 7.6 mio ha in 2008, i.e. 4.3% of EU-27 utilised agricultural area (UAA). In the period 2000-2008, the average annual rate of growth was 6.7% in the EU-15 and 20.0% in the EU-12” (EU 2010). In 2007 2.7% of the cattle herd is organic in the EU. In 2007 there were 2.4 mio heads of certified bovine animals, the largest producers being Germany, Austria, the United Kingdom and Italy. Germany is the largest dairy producer with more than 0.1 Mio cows. However, the Member States with the largest share of certified organic cows in the total number of cows are Austria (15.6%), Denmark (9.6%) and Italy (3.2%) illustrates the proportion of organic dairy production within the EU-28 countries.

The labeling of products from organic production systems is worthy of particular mention, as such organic produce is available in most countries. In order for a product to be certified organic the farm of origin must be inspected by a credible third party state or private organisation to verify that all the requirements of the certifying control body are adhered to. While sustainability of production would be enshrined in the goals of organic systems the term organic is not synonymous with sustainable on the broader sense outlined above which includes issues like food supply.

If a farmer considers working according to the rules of organic farming, he has to think about different aspects concerning cattle housing. National regulations on organic farming may differ from country, but as a general agreement to provide a worldwide standard on producing organically, the Codex Alimentarius of FAO/WHO has been elaborated in order to harmonize standards and to facilitate international trade. The Codex Alimentarius can be seen as a minimum standard on organic farming. One major player in organic production is the EU, setting a standard on organic farming, which is mandatory for all producers within the 27 member states as well as setting a standard for those countries who are importing organic products to the EU.

Codex Alimentarius of IFOAM “Guidelines for the Production, Processing, Labelling and Marketing of Organically Produced Foods” includes relevant phrases for cattle housing:

- “All mammals must have access to pasture or an open-air exercise area or run which may be partially covered, and they must be able to use those areas whenever the physiological condition of the animal, the weather conditions and the state of the ground permit.”
- “Livestock housing must have smooth, but not slippery floors. The floor must not be entirely of slatted or grid construction.”
- “The housing of calves in individual boxes and the tethering of livestock are not permitted without the approval of the competent authority.”

The influence on the design of dairy cattle buildings by organic farming systems from relevant regulations, for example Codex Alimentarius and other EU directives, are compared in Table 2.4.4.2.2. Note: there may be local variations to these regulations in different countries.



Table 2.4.4.2.2: comparison of standards on organic farming regarding cattle housing.

	FAO/WHO "Codex Alimentarius"	EU-Organic farming 889/2008
Flooring	Must not be fully slatted	Max. 50% slatted floor
Dehorning	By exception	By exception
Group housing of calves	-	Starting 2 <sup>nd</sup> week of life
Stocking density indoor	-	4.5 m <sup>2</sup> /dairy cow
Stocking density outdoor	-	6 m <sup>2</sup> /dairy cow
Exercise yard	Either exercise yard or pasture is mandatory	Access to grazing areas and exercise yards mandatory

Besides that, typical differences between organic and conventional managed dairy houses are:

- Access to a partly uncovered exercise yard is often realized by designing an outside feeding table (separate roof) connected by an open passage way to the lying area in order to fulfil the legal requirements efficiently
- Depending on the national organizations, housing of horned cows would require an extra space to the above mentioned (Table 2.4.4.2.2) space requirements of approximately 25 % as well as feeding racks with appropriate access.

Note : tied housing are no longer allowed in some countries.

### 3. Aspects of design

Nowadays, two major housing systems for dairy cows are in use in most countries: tied housing systems for small herds and loose housing systems for middle sized herds to very large sized herds. Tied housing restricts the cows freedom of movement and many activities (standing, lying, feeding, milking, etc.) take place at the same location. In contrast to this, loose housing allows cows to move freely and usually comprises a lying area, a feeding passage or area, a standing and walking (exercise) passage or area, and a milking area.

At present tied housing systems are less popular than in the past because they are less comfortable for the cows and very intensive in labour for feeding, milking and manure management. However, tied housing systems are still favoured by many smaller herds where the labour force is limited and probably only provided by the owner. This is because of tradition, familiarity with the system and the regular intimate contact with the cows and the majority of work occurring in, or near, one building. Loose housing systems provide more comfort for both the stockperson and animals and thus can improve production and welfare. Therefore, loose housing should be preferred whenever possible.

#### 3.1 LOOSE HOUSING SYSTEMS

##### 3.1.1 INTRODUCTION

Three major types of loose housing systems will be considered: cubicle systems (free-stalls), straw yards and sloped floor systems.

**Cubicle systems (free-stalls):** Cubicles are individual spaces where cows are provided with a reasonably clean, dry and resilient bed upon which they can lie. The cubicle must have dimensions that allow the animal to lie down and rise up without injury and to rest comfortably. The cow is free to enter and leave the cubicle at will. Since cubicle houses can work with very little bedding material they often produce slurry manure. With liberal use of bedding material they can also produce solid manure. Properly designed cubicles should ensure that cows move backwards as they stand up and thus deposit the faeces and urine into the access/dunging passages rather than on the cubicle bed. However, a comfortable resting position for the cow may still result in small quantities of faeces on the rear part of the cubicle.

**Straw yards (straw courts, bedded packs, compost packs):** Straw yards are unobstructed bedded lying areas for a group of cows, that may accommodate all or only part of the herd. Bedding is spread on top of a floor, with little ( $\leq 2\%$ ) or no gradient. Soiled bedding accumulates in a deep layer which is removed when necessary. Regular grooming of the pack including removal of manure and addition of fresh bedding adds to cow comfort and cleanliness. The layout and dimensions of the bedded area must be such that each animal has enough space to rest without being disturbed by other cows, and to allow them to circulate easily to feeding and drinking facilities.

A recent modification of these systems in the US is called the composting barn. With this system a deep layer of small particle dry bedding material is placed in the resting area. The pack area is agitated at least twice a day with a tractor with a mounted tooth type cultivator implement or rototiller. This incorporates manure into the bedding and also lifts and fluffs the mixture to encourage aerobic decomposition (composting) of the material. Truck loads of fresh

bedding are added when the moisture content of the pack becomes high enough that bedding sticks to the cows. The barn also serves as a manure storage area and typically the bedding and manure are allowed to build up for 8-12 months before cleanout and land application of the composted manure. These barns are built with high roofs to accommodate machinery, manure pack build-up and insure good natural ventilation with curtain sidewalls. The lower walls surrounding the pack will usually have 1.0 m or higher concrete or timber retaining walls to enclose and support the deep pack. A feed alley and feeding fence run along one side of the pack area.

**Sloped floor system:** Sloped floors are unobstructed bedded lying areas for groups of cows. The floor will have a gradient of 10% to 16% and the activity of the cows causes soiled bedding to move down the floor to the bottom of the slope, where it is collected. The sloped floor system is often not recommended for dairy cows, because it is more difficult to manage hygiene and udder health compared to other systems. So, this system is more often used for beef cattle (CIGR design recommendations of beef cattle housing, 2002) and heifers aged over 12 months until around 24 months, i.e. prior to calving, and will not be discussed in this document.

In certain countries, out-wintering-pads (OWP) have become an alternative method of accommodating cattle to conventional sheds. The OWP provides a drained lying and loafing area outdoors for the animals on a bed of woodchips. The OWP is operated at a much lower stocking rate than conventional accommodation. However, the effluent produced from an OWP has a high concentration of pollutants. Underneath, in a drainage system, the effluent is contained by clay soil or a plastic liner and the effluent is collected and stored before being recycled onto a suitable crop etc. The woodchip bed retains most of the nutrients produced by the livestock and these woodchips are also recycled where appropriate. In colder climates windbreak fences or hedges may also be incorporated to provide additional shelter. Concern for udder health, cleanliness and milk quality make these systems more suitable for drier warmer climates. Seasonal grazing herds may use these as over wintering lots for non-lactating cattle.



Figure 3.1.2.1: elements of a cubicle.

### 3.1.2 CUBICLE SYSTEMS (FREESTALL)

The cubicle is an extremely important element of the cow's environment, affecting positively or negatively its comfort, cleanliness and health. Cubicles must provide a clean, comfortable and secure lying space for cows. Cows should be able to enter and leave cubicles easily and lie-down and rise without interference. Animals must be able to express their natural lying positions (see Section 2.2.3.1). Additional considerations are freedom from injury, cleanliness, bedding requirements, labour efficiency and durability.

**Partitions:** they separate adjacent resting spaces (cubicles) and serve to control the position of cows without unduly restricting their movement. Cubicle partitions of various shapes may be supported in a variety of ways i.e. by free-standing vertical posts or cantilevered from the cubicle front assembly etc.

**Bases:** permanent or semi-permanent materials form the bottom/base or floors of cubicles. Commonly used materials include concrete, clay and stone-free subsoil.

**Bedding:** any substance or material that is used to improve cow comfort and/or hygiene. Two types of bedding can be distinguished; a) loose material such as straw, sawdust, wood chips or sand either as a deep layer (200 mm) placed directly on the base of the stall or a thin layer over a mat or mattress; or, b) materials fixed to the base of the cubicle such as rubber mats or various synthetic mattresses.

**Kerb (curb):** usually forms a step (max. 200mm) that separates the cubicle area from manure in the access/dunging passage.

**Neck rail:** often a metal tube (rigid neck rail) or flexible strap that is placed across the top rail of the cubicle partition to encourage cows to move backward on rising and prevents them from standing too far forward. Sometimes a **head rail** is used to prevent cows going too far ahead in the cubicle (see figure 3.1.2.4.2).

**Brisket boards or tubes:** elements placed on the floor at the front of the cubicle. They aid the cow in positioning herself in the cubicle while resting or standing and may retain any bedding stored at the front of the cubicle.

**Bedding retainers:** often formed of boards or pipes (possibly MDPE but not steel). They are fixed to the floor across the rear of cubicles to retain bedding (particularly sand) in the cubicle. This may also be formed by extending the kerb above the floor. The length of stall provided for the cow to rest in must be extended to account for the thickness of the retainer or extended kerb.

#### The cubicle comprises several elements :

- neck rail
- cubicle partition or division plus support post (to the left)
- brisket tube or board
- slightly sloping base with bedding or a mattress for cow comfort
- kerb to aid separation of the cow from the access passage

If the benefits of the system are to be realised, proper conditions must be maintained so that cows use the cubicles. Poorly designed cubicles may lead to cows lying in passages or elsewhere. Wet and contaminated cubicle beds are likely to contribute to an increased incidence of mastitis. Consequently careful attention to the design of cubicles, including their relationship to other elements of the housing, and their maintenance by the farmer is most important.

It is recommended that the cubicle be inspected and groomed at least twice a day and fresh bedding added when necessary. Usually this is done when cows are collected for milking. In buildings with AMS, where cows visit the milking station whenever they want, this task is more difficult and must be done throughout the day. AMS managers may choose to make several trips throughout the day around the barn inspecting cows and also taking care of cubicles when they are empty. An alternative is to quietly work on a few cubicles at a time in an effort to reduce the number of cows that are interrupted during their chosen rest time.

### 3.1.2.1 Design considerations

The cubicle must be long enough to allow appropriate positioning of the neck rail to allow the cow to enter the cubicle, lie down, rest comfortably without any injury and rise up again; and yet be short enough to limit manure and urine falling onto the cubicle bed. A shorter length of the cubicle or a neck rail moved closer to the kerb will tend to prevent soiling of the rear of the cubicle, which is important to good udder health. However, too short a length can cause cows to refuse to use the stalls, to stand partially in the stalls or to lie over the kerb with the risk of injury and soiling of the udder from manure in the passage. Cubicle length and neck rail placement should accommodate the longest cows in the herd (see Table 3.1.3.5.1 values for positioning of the neck rail).

The cubicle must be wide enough for the cow to lie comfortably, but narrow enough to discourage the cow from turning around. In addition, the cubicle should accommodate the natural rising behaviour of the cow. The cow should not come into hard contact with the cubicle partition or the neck rail in such a way as to cause injury. This is particularly important while the cow is in the act of lying down, since the last stage in this movement is uncontrolled by the cow.

As a cow rises from a lying position she lunges her head forward to transfer the weight from her hindquarters. She then raises her hindquarters before raising her front. To accommodate this natural forward transfer of weight the cow thrusts her head forward by between 0.5 m and 0.9 m as she lunges. If the forward movement is restricted because the cubicle is too short or the cow lies too far forward, because of an incorrectly placed or missing brisket board, then the cow will have difficulty in rising. Cubicles traditionally do not provide enough lunging space in comparison with space used for this movement in pasture (from 1.20 m to 1.40 m for head space plus lunge space).

The space needs of a cow with respect to lying and rising consists of:

- body space, i.e. the space from the rear of the cow to the front of her carpal joint
- head space, i.e. space in front of the cow occupied by her head while lying; and
- lunge space, i.e. the additional space necessary for the thrust of the cow's head as she lunges forward during rising.

Space required for a resting animal (body and head space) should be included within the cubicle space as defined by

rear kerb, side partitions, brisket tube, neck rail and cubicle front. Lunge space may be included within the cubicle space (non space sharing cubicles, closed front cubicles) or outside the cubicle (space sharing cubicles or open front cubicles) with the cow able to extend her head and neck forward outside her cubicle into an alley or outside space or into the front of a facing cubicle.

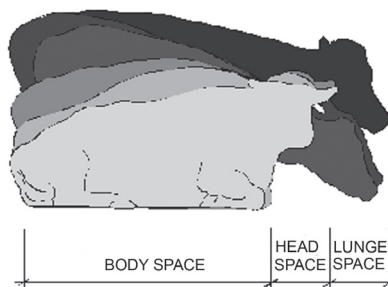

Figure 3.1.2.1.1: natural movement of a rising cow.

### 3.1.2.2 Space sharing cubicles

If cubicles are too short to permit the cows to lunge forward, the cows must share the space on the cubicle to the side or from the cubicle in front of her to rise up more easily. Sharing head space may be a solution for existing cubicles that are not long enough but when designing new buildings it is advisable to use the recommended dimensions for cubicles so that the cows are not forced to share space.

Head-to-head cubicles offer the opportunity to use space in the opposite cubicle to gain lunging space, providing the fronts of the cubicles are properly designed. In this case lunging space is not really restricted for each cow.

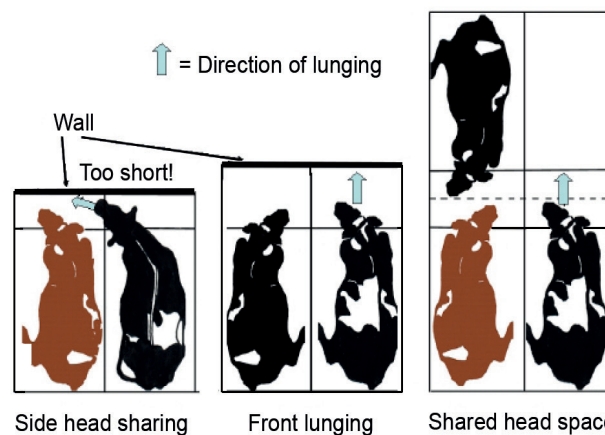

Figure 3.1.2.2.1: ways of providing space for a rising cow.

The unobstructed openings beneath or above the lower rail at the front of some models of cubicle partitions allow the cow to lunge forward into a neighbouring cubicle when rising. This should be considered as a possible help, but this additional space cannot totally compensate for insufficient lunging space because, effectively, it has to be taken from the opposite lying area.

Side head sharing cubicles allow cows to lunge through an opening to the side of the cubicle partition into the adjoining cubicle and may be used to make existing short stalls more cow friendly. However, side lunging is not normal cow behaviour, but cows have demonstrated an ability to learn this manoeuvre, but it can reduce cubicle usage if the cow does not adapt to this. As cows prefer to lunge forward, it is better to provide sufficient length that will allow for this, rather than use this type of cubicle in new construction.

### 3.1.2.3 Cubicles without space sharing

If space sharing is not provided for, then individual cubicles will need to be long and wide enough to accommodate normal cow movement, particularly rising. Cubicles long enough to accommodate the body space plus the head space of the lying cow require a brisket tube, or board, to prevent the cow from lying too far forward in the cubicle. The neck rail will discourage the cow from moving too far forward when standing and when the cow enters the cubicle.

### 3.1.2.4 Cubicle partition

The cubicle partition extends from the front of the cubicle to less than 300 mm and ideally no more than 200 mm from the passage (to prevent cows from walking along the rear of the cubicle beds). The partition should be sufficiently high to discourage turning around.

Cubicle partitions should have three unobstructed open areas as shown below:

- head zone (i)
- zone for controlling lying position (ii) (it will be small enough to prevent cows from lying under the partition, yet large enough to avoid trapping legs), and;
- zone for pelvis freedom preventing injury to hips and ribs (iii).

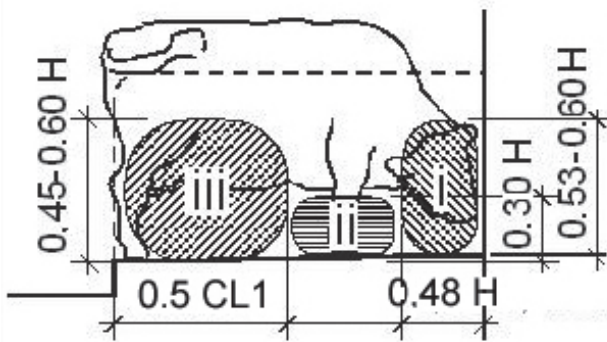

Figure 3.1.2.4.1: three zones of freedom in cubicles. (Note: H = Height at withers).

Note: Figure 3.1.2.4.2 (below) shows dimensions for cubicles with head-to-head space sharing. Also note that the shaded cow on the right is shown lunging forward to rise from a lying position and using the space in front of her i.e. from the cubicle opposite. Whereas, Figure 3.1.2.4.3 shows dimensions for a cubicle without space sharing.

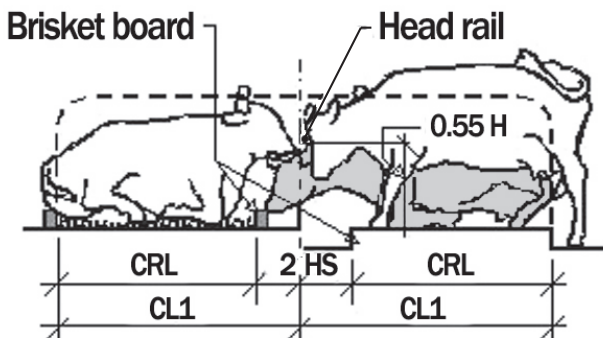

Figure 3.1.2.4.2: head to head cubicles with front space sharing.

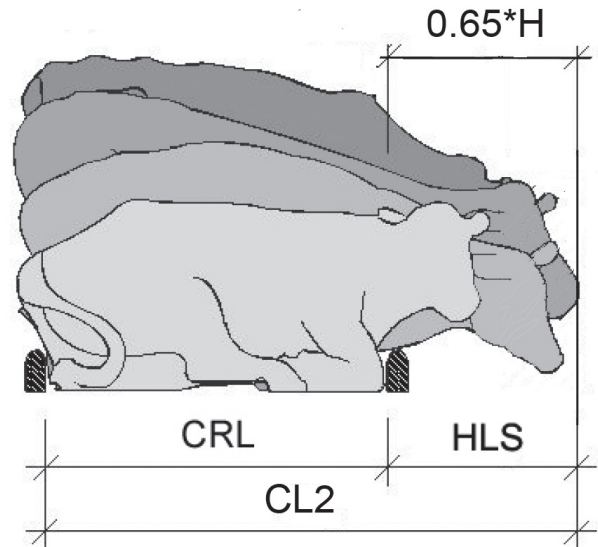

Figure 3.1.2.4.3: cubicle without space sharing.

### 3.1.2.5 Basic cubicle dimensions

All the following dimensions are related to the cow's body dimensions, L & H (in metres) discussed in Section 2.1.

#### Cubicles Width (CW)

This is calculated from formula (1) and represents the clear unobstructed distance between cubicle partitions.

$$CW = 0.83 H \quad (1)$$

#### Cubicle Resting Length (CRL)

This is calculated from formula (2).

$$CRL = 1.06 L \quad (2)$$

#### Head Space (HS)

This is the length space that should be allowed for the head of the cow when the animal is lying down. It is related to height of withers, H.

$$HS = 0.48 H \quad [\text{All types of cubicles}] \quad (3)$$

#### Head and Lunging Space (HLS)

This is the length of unrestricted space that should be allowed for the lying cow when lying down and for forward lunging of the cow when rising. It is related to height of withers, H.

$$HLS = 0.65 H \quad [\text{All types of cubicles}] \quad (4)$$

#### Overall Cubicle Length (CL)

This is an important value in the design of cow housing. It is obtained by adding the values of CR to the values HS or HLS respectively. Formula (5) is for head to head cubicles and formula (6) for all other types of cubicles.

$$CL1 = 1.06 L + 0.48 H = CRL + HS \quad [\text{Head to head, space sharing}] \quad (5)$$

$$CL2 = 1.06 L + 0.65 H = CRL + HLS \quad [\text{Non space sharing}] \quad (6)$$

### Neck Rail Height (NRH)

The neck rail height is obtained by the formula:

$$\text{NRH} = 0.80 \text{ to } 0.90 \text{ H (7)}$$

### Neck Rail Distance (NRD)

The horizontal neck rail distance from the kerb is obtained by the formula:

$$\text{NRD} = \text{CRL} + 0.10 \text{ (8)}$$

### Typical Cubicle Sizes (CIGR standard)

Table 3.1.3.5.1 shows calculated examples for three different cow sizes based on the CIGR-standard (see Section 2.1).

To avoid injury to larger cows, cubicle dimensions should be based on the average size of the 10% largest animals in the herd. The stock person will need to give some attention to the smaller animals in the herd to overcome any problems should cubicles prove too big for them.

*Table 3.1.2.5.1: cubicle minimum width (CW), cubicle resting length (CRL), head space (HS), head and lunging space (HLS), cubicle length (CL1 and CL2), neck rail height (NRH) and neck rail distance (NRD) according to formulas (1) to (8)*

Animal size (kg)	L (m)	H (m)	CW (m)	CRL (m)	HS (m)	HLS (m)	CL1 (m)	CL2 (m)	NRH (m)	NRD (m)
550-649	1.69	1.40	1.16	1.79	0.67	0.91	2.46	2.70	1.12-1.26	1.79-1.89
650-749	1.75	1.44	1.20	1.85	0.69	0.94	2.54	2.79	1.15-1.30	1.85-1.95
750-850	1.80	1.48	1.23	1.90	0.71	0.96	2.61	2.86	1.18-1.33	1.90-2.00

- CW = Cubicle Width (free space) = 0.83 H
- CRL = Cubicle Resting Length = 1.06 L
- HS = Head Space = 0.48 H
- HLS = Head and Lunging Space = 0.65 H
- CL1 = Cubicle Length (space sharing) = CRL + HS
- CL2 = Cubicle Length (non space sharing) = CRL + HLS
- NRH = Neck Rail Height = 0.80 to 0.90 H
- NRD = Neck Rail Distance = CRL + 0 to 0.10

Note: Pre-fresh cows (gestating cows) and post-fresh cows (cows with big udder) require more room and it is advisable to provide larger cubicles for these two groups of cows.

### **3.1.2.6 The cubicle base and bedding**

The cubicle base, together with any bedding or flooring, must provide a comfortable, cushioning, clean and dry surface. The base must support the cow and resist hollowing caused by the cow's claws when it lowers and rises. The base should be constructed and maintained to provide the desired slope for drainage. A base that slopes downward from 2% to 4% from front to rear encourages the cow to lie with her head toward the front of the cubicle and provides drainage to the rear of the cubicle.

The choice of bedding material may influence selection of a manure handling and storage system. The use of a short fine

bedding material will tend to reduce the amount of bedding material dragged into the dunging passage.

The use of bedding alone, on a concrete base without kerb, is unlikely to give a comfortable, resilient bed, unless large amounts of material is used (for instance more than 3 kg per cow every day of dry straw will be required). Cushions or mattresses, formed by sandwiching bedding material between layers of plastic fabric, have been used successfully, but moderate additions of bedding on top are still necessary. Rubber or plastic mats, or carpeting materials, seem to be less satisfactory when their thickness is under 30 mm and their density too low. Cubicles should be inspected twice-daily and wet bedding and manure should be removed. Clean, dry bedding should be added at least twice a week or more frequently. Frequent removal of manure from passages is also necessary. If the cleanliness of cubicles is neglected and they become excessively wet or soiled with manure, then infectious bacteria populations may exceed critical values. This will give rise to an increase in the rate of udder infection.

The cubicle base should be raised above the access/dunging passage by a kerb that is 150 mm high (exceptionally this could be increased to 200 mm maximum). The final height and construction should allow for a particular method of manure removal to be used, e.g. scraping or flushing. Long access/dunging passages and low scraping frequencies may require a higher kerb to keep manure from overflowing into the cubicle during scraping. Frequent scrapings prevent overflowing into the cubicles. The kerb should be high enough to discourage a cow from lying only partly in the cubicle. A kerb that is too high may cause udder injury and can cause too heavy loads on the rear claws and legs when cows enter and leave the cubicle or stand partly in the cubicle.

When cubicle bases are made of less permanent materials, such as clay, then hollows (created by the activities of the cow) will need to be filled periodically. A relatively flat surface allows the cow to lie-down and rise more easily and to lie more comfortably.

## **3.1.3 STRAW YARD SYSTEMS**

### **3.1.3.1 Space requirements for resting and moving**

Generally, straw yard systems are undivided bedded lying areas where animals realise all different kinds of behaviours such as standing, lying and resting, exercise etc. This unique area can be subdivided leading to two major subsystems: two area systems with a lying and a feeding area, and multiple area systems in which more than one area is provided for lying, feeding and exercise. In the latter case, any of the areas may be provided as uncovered outside yards.

In straw yard systems, for an individual cow the minimum space requirement can be defined as the space required for resting plus that required to allow free access from the resting area to feeding and drinking areas. Free access implies that cows can move without the risk of injury or aggressive interactions. The total space requirement depends on many different factors.

Empirical values exist for the individual space of cows. Figure 3.1.3.1.1 shows the space for a standing animal. It consists of the ground projection of the slightly enlarged body plus a larger tolerance area around the head. Figure 3.1.3.1.2 is for the lying animal, while Figure 3.1.3.1.3 shows the dynamic space needed for rising, which is about 1 m longer than the normal lying length.

One might assume that in closed loose housing, with a lying area adjacent to a feeding passage (two area systems), the minimum lying area corresponds to the body area of the lying animal plus tolerance space surrounding the head. For the normal Friesian cow these areas are 2.2 m<sup>2</sup> and 3.5 m<sup>2</sup> respectively, totalling 5.7 m<sup>2</sup>. However, experience suggests that a greater lying area may be necessary to avoid wet bedding, so that values from 6.5 m<sup>2</sup> to 7.0 m<sup>2</sup> are generally recommended.

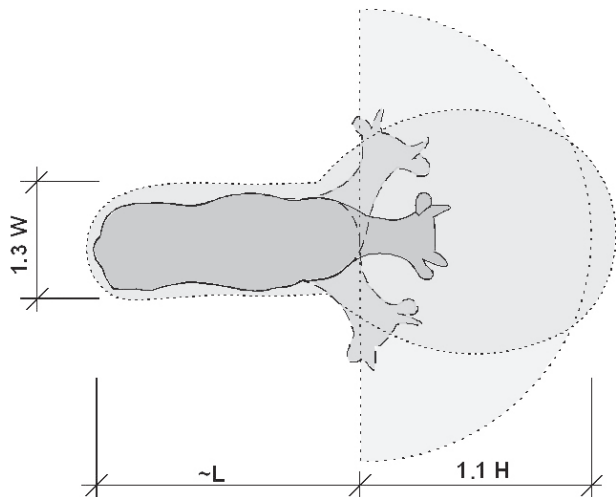

Figure 3.1.3.1.1: individual space required by a standing cow.

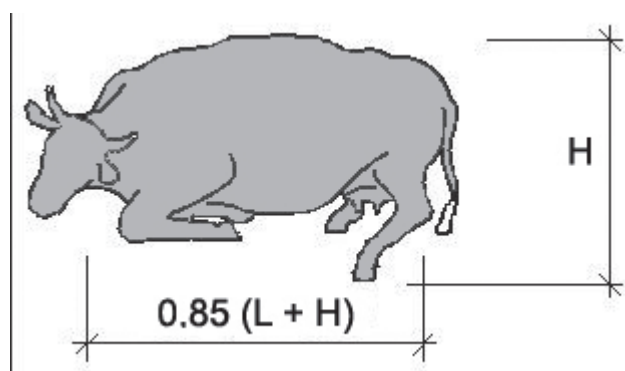

Figure 3.1.3.1.2: minimum space required by a lying cow.

If unbedded, freely accessible areas (a multiple area system) are provided for other activities, such as feeding, exercising (loafing), ruminating and grooming, then the bedded area can be reduced by up to 20 %. This is because certain behavioural and spatial needs are satisfied outside the lying place, i.e. in the loafing and feeding area.

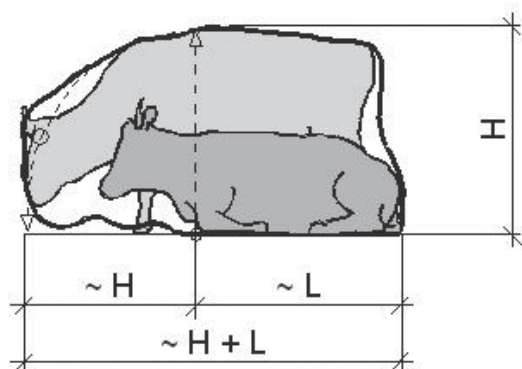

Figure 3.1.3.1.3: dynamic space required for rising.

On the basis of experience the following method of calculating minimum space requirements is recommended. The values L and H used are those defined in Section 2.1 and all areas are in m<sup>2</sup> per cow.

### Lying Areas (LA)

The space for lying and rising is calculated in accordance with the cow's length and the distance required to swing its head while rising multiplied by the width required for the cow to lie comfortably, i.e.  $[0.85 (L + H)] \times H$ . To allow sufficient space for movement between lying animals and to avoid disturbance of resting cows' additional space is required. To satisfy this space requirement would mean providing an additional area of between 1.38 and 1.65 times the above lying area, depending on the type of housing.

Note that the minimum lying area requirement corresponds to the actually available area for cattle. The total area is generally a little bigger, considering that some transition areas between the different zones of the system might be spoiled so that cattle could not rest properly on these parts of the bedded yard.

Based on the above, the minimum lying area requirements, LA1 and LA2 respectively, are given by the following formulas for:

- Two area, bedded lying area, systems (see Figure 3.1.3.1.4)

$$LA1 = 1.65 H [0.85 (L + H)] \text{ [Two area bedded]} \text{ (9)}$$

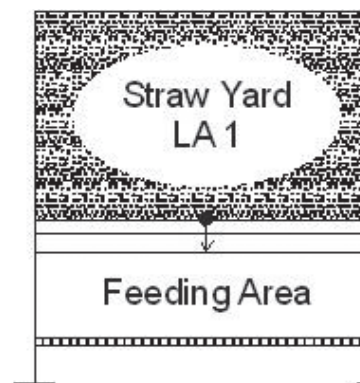

Figure 3.1.3.1.4: two area straw yard systems.

- Multiple area, straw yard (see Figure 3.1.3.1.5)

$$LA2 = 1.38 H [0.85 (L + H)] \text{ [Multiple area straw yard systems]} \text{ (10)}$$

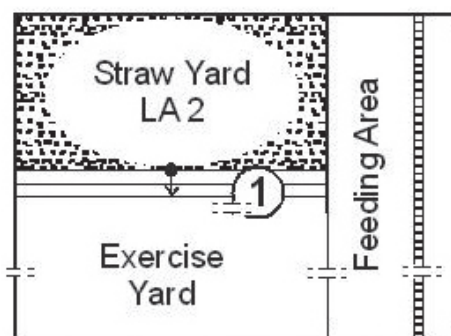

Figure 3.1.3.1.5: multiple area straw yard systems.

### Step depth (SD)

$$SD = 0.85 L \quad (11)$$

The step depth (0.85 L) represents the optimal design to prevent any injuries and slipping when cows go from the feeding or dunging alley to the bedding area. Experience shows that cows can manage situations with 2 or 3 steps having 300 mm height and 400 mm depth (see Section 3.1.4.3. as well).

Table 3.1.3.1.1 shows the calculated lying and total areas for different types of systems based on 3 different sizes of cow sized according to the CIGR standard (see Section 2.1, Table 2.1).

Table 3.1.3.1.1: minimum lying areas as determined for dairy cows from formulas (9) and (10)

Animal size			Lying area's	
Weight (kg)	L (m)	H (m)	LA1 m <sup>2</sup> /cow	LA2 m <sup>2</sup> /cow
550-649	1.69	1.40	6.07	5.07
650-749	1.75	1.44	6.44	5.39
750-850	1.80	1.48	6.81	5.69

$$LA1 = 1.65 H [0.85 (L + H)] \quad \text{and} \quad LA2 = 1.38 H [0.85 (L + H)]$$

Note: The space requirement is calculated from the body size and is a minimum. It can be larger according to yield, straw amount and management etc.

### 3.1.3.2. Shape of straw yards

The bedded area in straw yard systems should serve as the resting area. While its shape can vary to some extent it will affect the space available for the cows. Since cows prefer to lie down along the peripheral walls of straw yards, a rectangular shape is preferred to a square (Figure 3.1.3.2.1). The best shape is determined from a consideration of the feeding space and lying space for one cow (Figure 3.1.3.2.2). The distance from the bedded yard to the feeding area should be short and direct. The maximum distance between a feeding passage and the back wall of a straw yard should be about 10 m. This will minimise the risk of injury due to cows treading on each other.

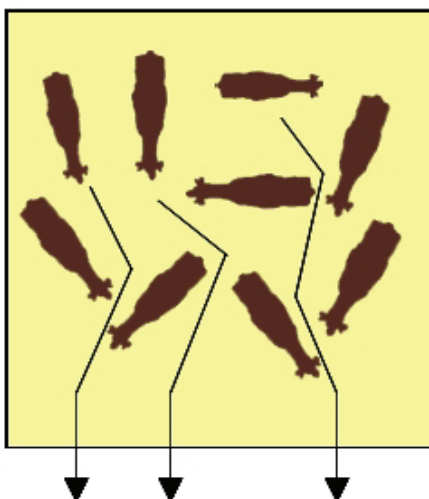

Figure 3.1.3.2.1: animal flow in square straw yards.

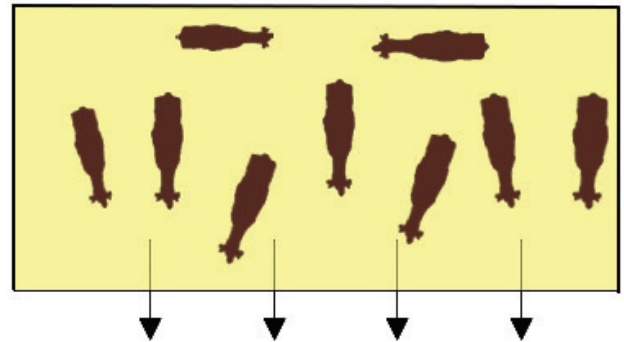

Figure 3.1.3.2.2: animal flow in rectangular straw yards.

### 3.1.3.3. The connection between lying areas and adjacent passages

A step is generally provided between a strawed yard lying area and adjacent passages. The height difference between the floor of lying area and floor of passages depends on the frequency of bedding removal from the lying area. The height will vary from 250 mm (or even 0 mm) for a 1 month cleaning interval. More than one step may be required with individual steps being 200 to 300 mm high and at least 400 mm deep. Attention must be paid to the fact that a long cleaning interval might adversely affect the health states of the udder. Regular removal of the bedding is recommended (every 6 to 8 weeks).

Passages can be slatted if the straw bedding is chopped or ground. With slatted passages additional space needs to be provided, as a wide step, between the bedded lying area and the passage. This is to prevent bedding being dragged onto the slats by the cows' claws. The minimum width of this step should be at least a cow's body length (L) as defined in formula (11). An alternative solution, not requiring as much space, is to fix a wooden beam between the passage and bedded area at the edge of the step.

Another recommendation to consider, particularly with a slatted feed stance, is to limit the locations along the feed alley where access can be made between the resting and feeding area.

In normal straw yards, exits to outside areas (exercise yard, collecting area, passages to pasture) should be located across as wide an opening as possible, or through a scraped passage.

### 3.1.3.4 Bedding management and use

In straw yard systems, straw is spread over the whole resting area. To keep animals clean 1.0 to 1.2 kg/day/m<sup>2</sup> is required. It is very important to use chopped straw of 200 to 300 mm in length. Long straw gives a wet litter with more dirty animals. Fresh straw must be added daily and it must be dry and free of mould. The surface temperature of the bedded area is influenced by the quantity of straw spread every day. Using too much straw (> 1.2 kg/day/m<sup>2</sup>) increases the surface temperature of the bedding area and has a positive influence on the development of micro-organisms living in the environment and on the infectious pressure exerted on the udder. Therefore, too much straw can be bad for the udder health (somatic cell count and clinical mastitis).

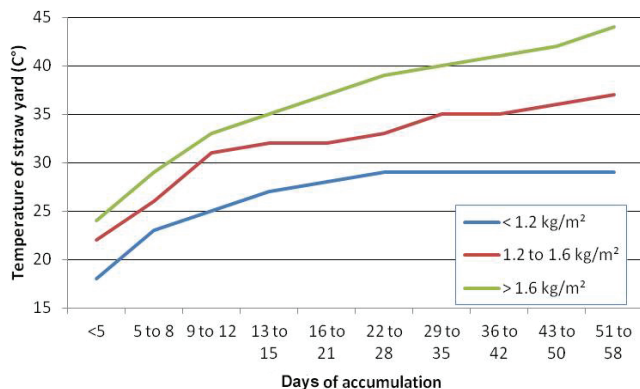

Figure 3.1.3.4.1: effects of straw quantity per day and accumulation time on temperature of the litter.

Below 0.7 kg/day.m<sup>2</sup>, animals are too dirty and the risk of poor udder health increases.

Inadequate management of the bedding area (lack of bedding material, overcrowding etc.) can reduce the cleanliness of cows and affect milk quality (somatic cell count) and increased mastitis.

### 3.1.3.5 Straw use

The demand for straw will vary depending on the layout, management, required cleanliness of the cows and climate.

The table below shows the approximate range of straw demand for bedding material depending on type and layout of the housing system:

The following management practices will help to reduce straw use:

- use old straw which is dry and of good quality
- decrease the stocking density (less animals per unit lying area)
- provide alternative areas for cows to use (multiple area systems)
- provide a feeding area separate from the dunging passage
- scrape the dunging passage at frequent intervals
- bed the floor more frequently (twice per day)
- feed cows with diets that produce drier faeces.

Table 3.1.3.5.1: typical bedding use in different housing arrangements.

Straw use (kg/day.m <sup>2</sup> )	System characteristics
1.0 - 1.2	Two area straw yard systems
0.7 - 1.0	Multiple area straw yard systems

## 3.1.4 ADVANTAGES AND DISADVANTAGES OF THE LOOSE HOUSING

### 3.1.4.1 Cubicle systems

Compared to the straw yard systems, cubicle systems can function with less bedding material (straw, sawdust, compost, sand etc.), but they need adequate management to keep a high level of animal cleanliness. Furthermore, it is

almost impossible to avoid a certain percentage of hock injuries.

The use of deep bedding reduces hock injuries considerably and improves cow comfort, cleanliness, udder health and milk quality (somatic cell count) etc.

Poor cubicle design, installation and management can result in poor cubicle usage. Problems can also arise if heifers are not trained to use the cubicle system before calving.

The optimal sizing of cubicles, passages etc. and positioning of drinkers, automatic feed dispensers etc. need special care and attention to detail.

Construction is costly and is specific for dairy cows. It is difficult to convert facilities for another type of cattle and to adapt to another breed, or where new regulations are introduced.

The level of investment is higher (manure storage capacity) than for the straw systems, but the annual costs for bedding and for labour are generally lower.

### 3.1.4.2 Straw yard systems

The system is comfortable for animals provided adequate space, use of bedding material and the management of bedded areas are optimal. Adequate management of the bedded area is needed to prevent udder health problems.

The cow has more freedom than in the cubicle system and learns very quickly how to use it. The potential of conflicts among cows is greater.

For the same number of animals the system needs more resting space than the equivalent cubicle system. The level of investment is lower than for the cubicle system, but the annual costs of the bedding (unless produced on the farm) and for the labour is higher.

The system implies the use of very large quantities of straw or other bedding material. The spreading of straw, manually or mechanically, needs a lot of time and adequate equipment and storage area (in open air or under a roof).

The system implies:

- a minimum slurry storage capacity,
- special handling equipment for bedding material, solid manure and slurry,
- special equipment to spread solid manure and slurry.

Generally speaking, somatic cell count is higher than for cubicle system.

Conversion of building for another type of cattle is possible and relatively easy to do.



### 3.2 TIED HOUSING

#### 3.2.1 INTRODUCTION

Tied housing restricts the cows' freedom of movement. Tie stalls will always be a compromise in order to meet different demands, because many activities take place in the same area. The same location is used for standing, lying, social interactions, feeding, drinking, milking and defecating/urinating. This situation is difficult to manage, but there are some points of good practice and husbandry, that will contribute to designing tie stalls that are more suitable with respect to animal welfare. This section aims to summarise those points with special regard to stall dimensions, flooring and tie systems.

Tie stalls should only be used when animals can graze outdoors or can exercise in an open yard throughout the summer and have the opportunity for periodic exercise in an open yard in the winter (ideally every day).

#### 3.2.2 DIMENSIONS OF TIE STALL ARRANGEMENTS

The length of standing space for the cow is important. A standing or stall length that provides for all the needs of the cow for standing, reclining/rising, resting, feeding, drinking and milking is sometimes referred to as a "short length." Longer standings (medium and long standing lengths) appear to offer no advantage to the cow and if not cleaned regularly often also result in dirtier cows. Therefore, this document recommends, so-called, short stall standing lengths.

Figure 3.2.2.1 shows a cross section of a short standing tie stall.

Solid manger walls (separation between the standing surface and the feed manger) must not be higher than 32 cm and not thicker than 12 cm. Flexible manger walls (rubber belts) are recommended, because they do not impair the forward lunge of the cow when rising. They must not be higher than 42 cm and the upper board must not be sharp-edged and should be cut at every stall.

All dimensions in chapter 3.2.2 are expressed in metres and in terms of the body dimensions L, H & W as defined in Section 2.1.

#### Manger width (MW)

Value (1) and (2) below show manger width (MW) for animals of different body dimensions. An appropriate manger width must guarantee that a sufficient fodder supply remains attainable for the animal.

$$MW = 0.60 \text{ [For animals up to } H = 1.4 \pm 0.05 \text{]} \quad (1)$$

$$MW = 0.50 \text{ [For animals up to } H = 1.3 \pm 0.05 \text{]} \quad (2)$$

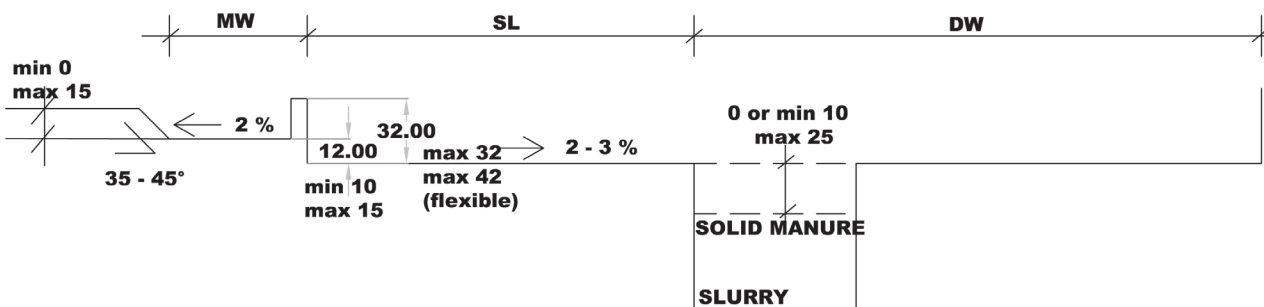

Figure 3.2.2.1: longitudinal section of a "short standing" tying stall (All dimensions are expressed in cm.).

#### Stall length (SL)

This is calculated from equation (3).

$$SL = 0.92 L + 0.3 \quad (3)$$

Table 3.2.2.1 shows stall lengths based on CIGR-standard data (see Section 2.1.2, Table 2.1.2.1).

#### Stall width (SW)

The stall width must ensure the comfort and safety of adjacent animals and guarantee that all animals can lie simultaneously. Equation (4) shows the required stall width.

$$SW = 0.86 H \quad (4)$$

Table 3.2.2.1: stall length (SL) and stall width (SW) based on CIGR standard dimensions for cows.

Animal size			Length	
Weight (kg)	H (m)	L (m)	SL (m)	SW (m)
550	1.35	1.61	1.79	1.15
650	1.40	1.69	1.85	1.20
750	1.44	1.75	1.90	1.25
850	1.48	1.80	2.00	1.30

#### Dunging and walking passage width (DW)

The dunging and walking passage must provide enough space for routine tasks (milking, cleaning, help at parturition) to be easily carried out. In addition there must be enough space for individual cows to move out of and into their standings and for all animals to be driven in and out of the building. It should correspond to the length of an animal ( $DW = 1.45 L$ ) and must not be less than 2 m.

#### Rows of stalls

To accommodate different sizes of cows, tie stalls may need to be of different sizes. One might consider the following options when installing rows of stalls.

For small units, provide:

- A tapered arrangement, so that the stall length at one end of the row can accommodate the mean of the 25% smallest cows in the herd while at the other end the stall length can accommodate the mean of the 25% largest cows in the herd. The same procedure can be applied to the widths of stalls provided. This approach is unlikely to prove satisfactory if cows and heifers are mixed.

For larger units, provide:

- Rows of stalls of adjustable length but fixed width.

### 3.2.3 STALL FLOORS AND BEDDING

Cows need a soft and clean lying area that affords sufficient grip to prevent the animals from slipping when rising and reclining. Thin hard rubber mats (0.02 m thick) without any bedding material do not meet these requirements. Sawdust or shavings are not recommended, because they can cause skin irritations and lesions. Where above 2.5 kg straw bedding per animal per day is used as the only bedding material, large amounts of straw is often dragged into the dunging passage. It is then labour intensive and relatively expensive to clean every day.

Soft foam rubber or plastic mats (“animal comfort mats”) more than 0.03 m thick, should be preferred to conventional hard rubber mats. Ground or chopped straw (0.4 - 0.8 kg per animal and day) should be spread on every rubber mat to keep the lying area drier. Cow mattresses (soft two-layer mattresses or mattresses filled with shredded rubber) were initially developed for cubicles. These designs have been successfully used in tie stalls, but hollows/holes can be created by the cows’ hooves remaining in the same place for long periods. Mattresses with pre-sown tubes are preferable to systems with loose rubber fill and also more durable cover materials are recommended in tie stalls.

The stall can also be restricted by a board, pipe or round timber (bedding retainer) at the back edge and covered by a mix of straw and other organic material made by the farmer himself (like a cubicle). Thereby, animals have a comfortable bed and only 0.3 kg to 1 kg straw per animal per day is needed. Further details concerning flooring are described in Section 3.1 (see 3.1.3.6 The cubicle base). It is important to avoid steps which are too high (max. 0.25 m at the back edge of the standing). If necessary the dunging passage must be raised.

The earth bonding of metal meshes (concrete reinforce) is recommended under the stall and manger areas. This is to eliminate possible stray voltage problems.

Dunging and walking passages must not be harmful to claws. They should also provide good traction for the cow when walking or standing, especially when animals are using them e.g. for going to pasture. Dunging passages can either have solid floors and be separated from the lying area by a step or the gutter can be covered by a grate. As well as being kinder to the claws, grates must provide a good throughput of dung. The clear distance between bars (“spacing”) should not exceed 40 mm and the bars should at least have a width of 25 mm. The surface must be even and free of burrs. Grids with a honeycomb design or metal grids with rubber coating have a favourable effect for animal claw comfort.

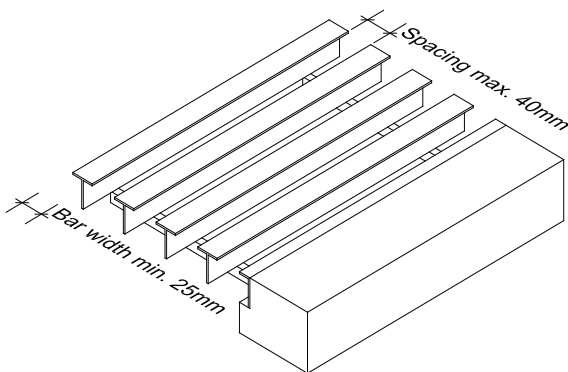

Figure 3.2.3.1: design of grates for tie stall housing.

### 3.2.4 THE SYSTEMS AND FACILITIES FOR RESTRAINING THE ANIMALS

A number of different tie systems are currently used in practice and frequently new or modified designs are developed. In principle tying devices must:

- allow normal rising, standing, lying-down and lying behaviour
- allow normal feeding behaviour
- be non injurious to the animals
- allow the animal freedom of movement whilst preventing it from getting too far into the feed manger and from dirtying the lying area
- allow movement of at least 600 mm in longitudinal direction and 400 mm in transverse direction (parallel to the manger) and offer the animals enough freedom in vertical line.
- should also reduce agonistic behaviour with the neighbouring cows while feeding.

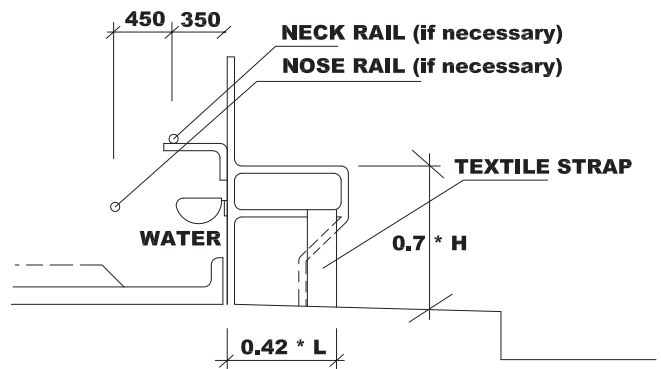

Figure 3.2.4.1: spatial arrangement of neck and head rails, partitions and water bowls.

The provision of partitions between standings will restrict diagonal standing and lying. Cantilever dividers do not have a post that extends into the base of the lying area. They are the most suitable for animal comfort and for the installation of new base and bedding concepts. Partitions should not be higher than 0.7 H and should not exceed a length of 0.42 L (i.e. for cows 0.70 m). Flexible textile-straps are preferred for this purpose. They can be fixed from projecting metal brackets and can even replace a solid partition. Figure 3.2.4.2 shows spatial arrangement of partitions.



Figure 3.2.4.2: flexible textile strap without solid partition (Schick, 2000).

### 3.2.5 CALVING AND NURSING BOXES

Separate calving boxes should also be available in tie stalls. Additional nursing boxes are recommended. Further design recommendations are given in chapter 3.10.

### 3.2.6 WATERING

The absolute minimum requirement is that a water bowl should be mounted at every second stall division. However, this means that cows share the water bowls which can be stressful for submissive cows, can limit their water intake and reduce milk yield. Therefore the provision of a bowl in every stall is preferred. Recommended position of the water bowl is shown in figure 3.2.4.1.

### 3.2.7 COW TRAINERS

Allowing the cow freedom of movement, may result in a considerable proportion of faeces being deposited on the lying area. Maintaining a clean lying area is labour intensive and requires significant amounts of litter. Otherwise the result will be a greater probability of dirty animals or infected teats. To prevent this, electric cow trainers, that force the cow backwards as she defecates, are sometimes used.

The use of trainers raises serious welfare concerns and the following points need careful attention if cows are not to be unduly stressed:

- the cow trainers must be located very carefully at a minimum height of 50 mm above the withers, when the cow is in a normal standing position (see Figure 3.2.7.1)
- the trainers must be adjusted to suit each individual animal in its stall
- the trainers must be switched off whenever the cow is in heat (oestrus), is calving or when the cow is being handled in any way
- it is recommended that cow trainers be used, i.e. switched on, only once a week. It is claimed that this will not lead to dirtier cows
- special devices (with low discharge energy, time switch, automatic cut off) must be used. Do not use devices designed for pasture fences.

The use of cow trainers constrains certain behaviours (mainly oestrus and grooming behaviour) and limits the movement of cows. Consequently the cow must be provided with regular and substantial opportunities to exercise and the animals may need to be regularly and thoroughly cleaned and groomed by the herdsman. In certain countries electric cow trainers are forbidden.

Some alternatives to the electric cow trainer has been developed:

- The covered cow trainer is a form of electric cow trainer that is covered by a plastic or wooden cover, which can

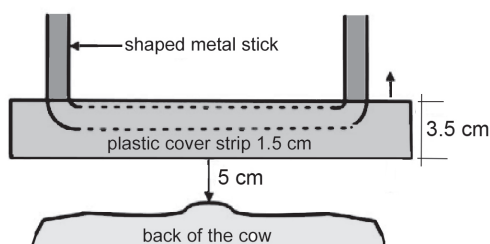

Figure 3.2.7.1: correct adjustment of an electric cow trainer.

be pushed upwards, e.g. by the cow, uncovering the metal stick (see Figure 3.2.7.2).



Figure 3.2.7.2: covered cow trainer (AK Milchviehproduktion Voitsberg, 2004)

- The “Aktorik” uses a sensor controlled mechanical-pneumatical metal bow to force the cow backwards (see Figure 3.2.7.3). The main disadvantage of this system is its high price.

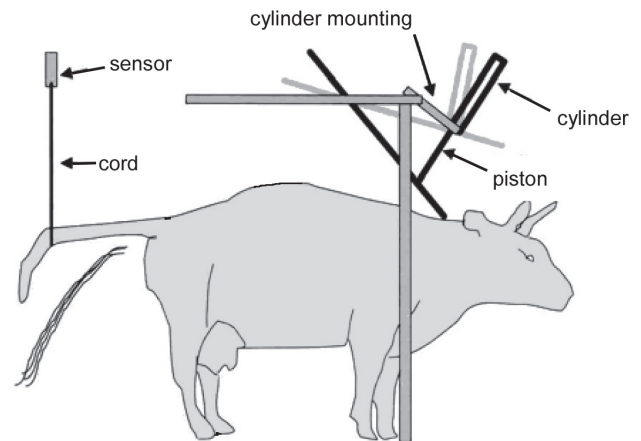

Figure 3.2.7.3: mechanical-pneumatic system (“Aktorik”).

## 3.3 FEEDERS

### 3.3.1 INTRODUCTION

The feeding space is an important part of the building as it may be used by the animals for between 5 to 9 hours a day. Feeding barriers and mangers for cattle should provide access to a large volume of feed, prevent bullying and feed wastage and be non-injurious to the animals. Configurations that do not cause discomfort or injury, while offering maximum forward reach and limiting sideways reach to reduce bullying, are the most suitable. When the feeding area is outside the building it should be protected with a shelter.

### 3.3.2 NUMBERS OF FEEDING PLACES

Ideally all animals should be able to eat at the same time. This means that a feeding place should be available per animal. However, if feed is permanently (day and night) available for the animals, up to 2.5 animals per feeding place can be tolerated. If less places than the number of animals are available at the feeding barrier, a self locking barrier should not be used.

### 3.3.3 GENERAL DIMENSIONS

#### 3.3.3.1 Forward reach length

In order to get additional food, cows will press their shoulders against the feeding barrier, which may cause injuries. The fodder should be within the normal reach of the animal (Figure 3.3.3.1.1). The reach depends on the size of the animals and the configuration of the feeding barrier. In general, the greater the height difference between the feeding stance and manger, the greater the reach. However, to reduce the waste of feed the height difference should be limited to between 15 and 20 cm. Research has shown that inclining the barrier by up to 20° towards the manger (i.e. away from the cow) increases the volume of food within reach of the cow whilst reducing the risk of injuries. The separation wall between manger and animal should, preferably, be less than 15 cm thick but not more than 20 cm thick.

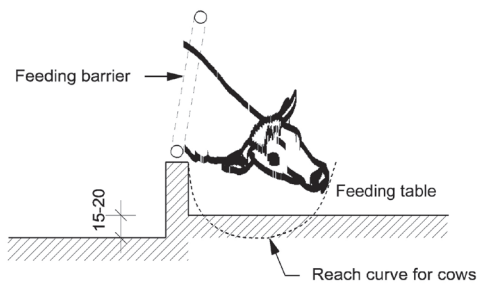

Figure 3.3.3.1.1: reach curve for cows.

#### 3.3.3.2 Crib or feeding table

Cribs limit pushing the fodder out of reach (Figure 3.3.3.2.1). They should be at least 60 cm deep at a height of 20 cm. Mangers are more expensive than flat feeding tables and need more labour to be filled and cleaned. When feeding silage the concrete should be protected against aggressive silage juice (e.g. polyester or epoxy resin coating).

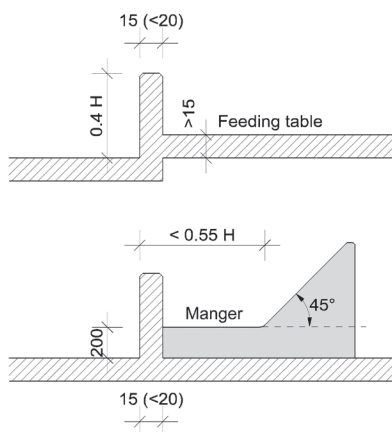

Figure 3.3.3.2.1: feeding table and manger.

#### 3.3.3.3 Feeding space per animal

The spacing between cattle places (CS) is given by the following formula:

$$CS = 1.3 W$$

where W = width of chest of the animal

Hence the total length of barrier required can be determined. See the table below.

Table 3.3.3.3.1: calculated cattle place lengths for various sizes of animal

Weight (kg)	W (cm)	CS (cm)
550	50	65
650	55	71
750	60	78
850	64	83

#### 3.3.3.4 Feed stalls

Physical separation between adjacent cows, when they are at the feed barrier, can reduce competition and aggressive interactions especially for subordinate cows. This can result in increased dry matter intake. When the floor of the cow standing is elevated cows are not disturbed by scrapers in the feed stance passage and stand dry and clean during eating. This will hopefully result in better foot health (Figure 3.3.3.4.1). Using rubber mats on the cow standing can also help. The access passage/feed stance should be wide enough for two cows to pass each other without hindrance.

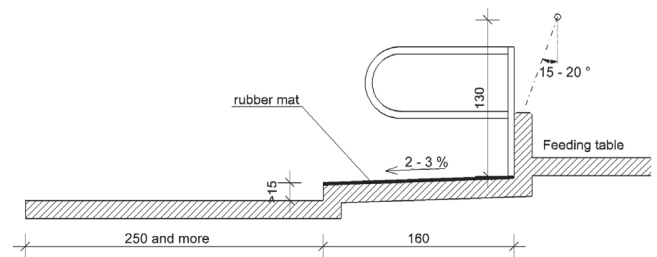

Figure 3.3.3.4.1: feed stall (dimensions in cm).

#### 3.3.3.5. Feeding table

The width of the feeding tractor passage depends on the feeding system. However, where feed is delivered to the trough (manger) using a mixer wagon, the tractor passage width needs to be at least 4m. Where two feed barriers face each other (in a building or between two buildings) the distance between them needs to be at least 5 m to allow adequate space.

Where the feed will be presented to the cattle using a conveyor the 'tractor' passage can be limited to the width of the conveyor. However, where an automatic feeding device is used, additional space may be needed at the head of the device to allow for the safe discharge or loading of the forage on/off the conveyor belt.

### 3.3.4 FEEDING BARRIER DESIGN

#### 3.3.4.1 Post and rail barrier

The withers of cattle are particularly sensitive and prone to injury, which means that positioning of the top rail is crucial. If the height of the top rail is lowered, so the risk of injury increases. Advantages of the rail barrier are low cost and easy access for cows. Waste of feed and no restrictions to sideways movement, which may encourage bullying, are the main disadvantages. On this basis a post and rail barrier should not be recommended for dairy cows. However, if it is installed the neck rail must be easy to adjust. Dimensions are given in the figure below.

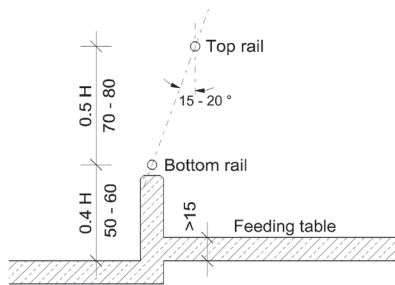

Figure 3.3.4.1.1: post & rail barrier dimensions. The dimensions are only appropriate for dehorned cows.

### 3.3.4.2 Diagonal bar barrier

This type of barrier forces cattle to angle their heads to gain access. The angle of the bars helps prevent food wastage as the animals cannot throw food over their backs and cannot move straight back out of the barrier with food in their mouths. Sideways movement is limited to some extent, though not equally on both sides. For maximum reach and minimum feed wastage, the bars should be angled at  $60^\circ$ . Dimensions are given below.

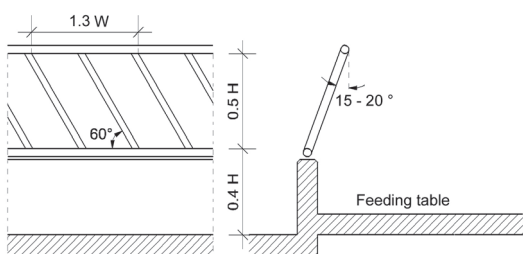

Figure 3.3.4.2.1: diagonal barrier dimensions.

### 3.3.4.3 Tombstone barrier

The tombstone barrier overcomes problems with bullying by limiting sideways reach and movement. However, vertical tombstones limit sideways reach excessively and thus limit the volume of feed within reach of the animal. Optimum sideways reach is achieved by splaying the tombstone at an angle of  $7^\circ$ . The cantilevered design of the tombstone barrier requires a heavy construction. As with the other barriers described, the tombstone should be angled towards the manger as shown below.

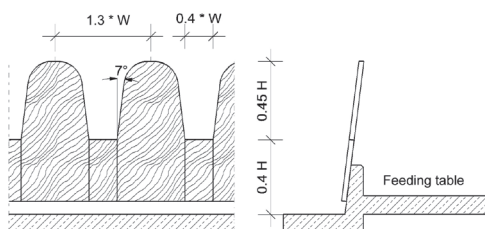

Figure 3.3.4.3.1: splayed, inclined Tombstone barrier dimensions.

### 3.3.4.4 Dovetail barrier

Of the designs discussed here, the dovetail barrier provides the best access to feed without causing injuries or feed wastage. The splayed partitions prevent bullying while allowing optimum reach and construction is lighter than a cantilevered design. The barrier may be constructed in wood on site at relatively low cost, or purchased in pre-fabricated steel sections. Dimensions of the dovetail barrier are shown below.

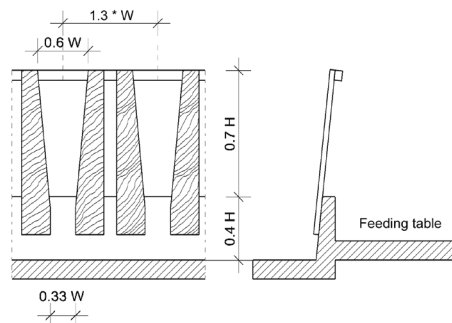

Figure 3.3.4.4.1: dovetail barrier, construction details.

### 3.3.4.5 Self locking barrier

Self locking barriers are often preferred because they allow cows to be constrained. This constraint offers the following management advantages:

- cows can be held for about 30 minutes after milking to prevent them from lying down on bedding until the sphincters of the teats have closed
- cows can be held for observation, veterinary attention, artificial insemination, during cleaning and maintenance activities
- wastage of feed, such as hay, is reduced
- feed competition is reduced.

Dimensions of a typical design are given below. The barriers are often mounted vertically, but there would probably be advantages in inclining the barrier at  $20^\circ$  as for the free access designs. Noise can be reduced when sliding bars are supplied with plastic stoppers.

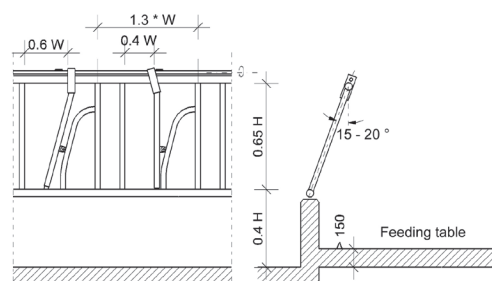

Figure 3.3.4.5.1: typical self locking barrier.

### 3.3.5 DEVICES FOR MOVING THE FEED

Moving feed automatically to the feeding barrier may help reduce the labour required to keep sufficient quantities of food in front of the animals. This may allow more animals to feed from the same length of the feeding barrier for more time. Where stock are fed silage in blocks, mechanical beams can be used to gradually push the blocks towards the feed barrier and hence the animals. However, there is a risk of fermentation in the silage blocks if they are not consumed quickly enough. So, keeping a limited amount of silage in the passage is advisable.

An alternative system (Figure 3.3.5.1), instead of moving the feed to the feeding barrier, the feeding barrier (and consequently the animals too) moves to the feed. This is similar to a self-feeding silo where the feeding gate is often moved by the animals. However, the lack of height difference between feeding table and feeding area and the additional labour for floor cleaning are the main disadvantages of this system.

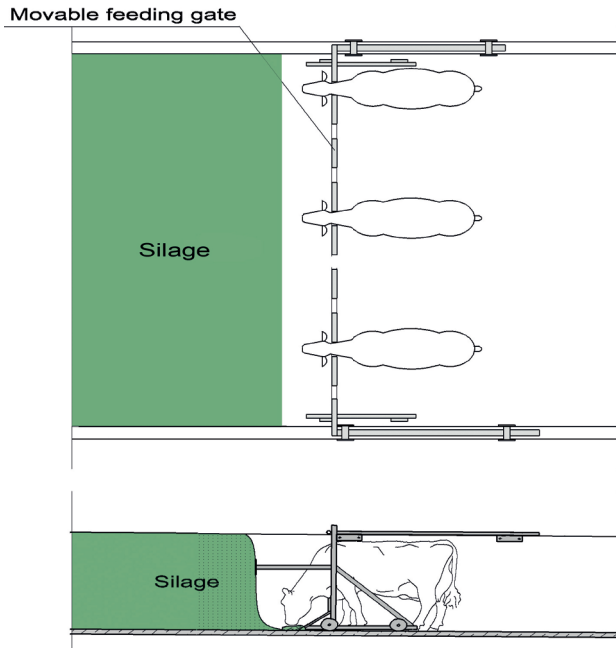

Figure 3.3.5.1: self-feeding silo with feeding gate moved by the animals.

For more conventional systems i.e. a forage wagon, an automatic ‘butler’ machine can be used several times a day along the feeding barrier to push the silage up to the barrier and even distribute supplementary feed. Another automated system is illustrated in figure 3.3.5.2. Here a flexible mat is fixed to the front of the feed barrier and feed placed on it. The mat is then raised to keep feed in front of the stock at all times.



Figure 3.3.5.2: a flexible feed pushing system (Schick, 2000).

### 3.3.6 HAY RACKS

A hay rack normally consists of two main compartments: one in which the hay is placed and one into which the animal pulls the hay before eating. Vertical bars spaced at 14 to 18 cm apart separate the two compartments. A manger at the base of the eating compartment collects hay dropped by the animal avoiding feed losses. The cattle gain access to the feeding compartment through a feed barrier. Because the sloping base of the hay compartment ensures that the hay always falls against the vertical bars forward reach is not a limiting factor. Consequently, there is no need for the barrier to be inclined. Any of the barrier designs discussed above may be used. A typical design is shown below.

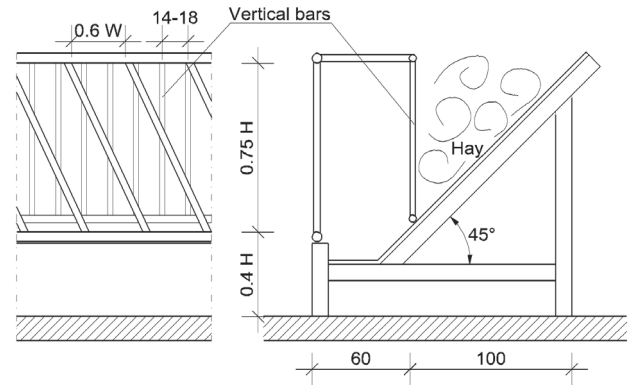

Figure 3.3.6.1: example of a hay rack with diagonal barrier.

### 3.3.7 BALE FEEDERS

Large round or rectangular feeders may be used for hay and silage. The amount of waste food depends on the design of the feeder. The bottom of the feeder should be closed up to a height of 40 cm. Angled feed bars or a tombstone barrier reduce the amount of hay or silage pulled out of the feeder and wasted. Bale feeders can be easily moved by a tractor and are suited for use in paddocks and pastureland.

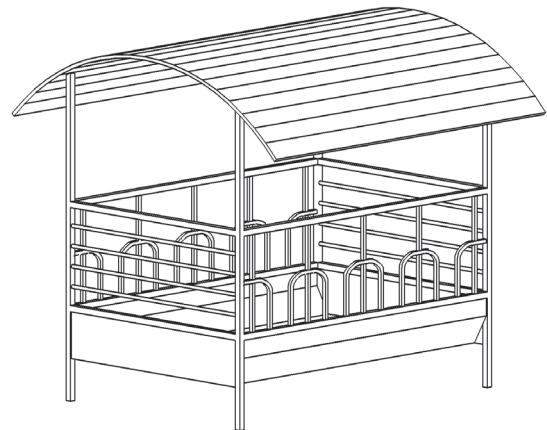

Figure 3.3.7.1: an example of mobile bale feeder.

### 3.3.8 CONCENTRATE FEEDERS

Milking cows need additional nutrients which are not, or cannot, be supplied exclusively through feeding forages. Traditionally cows are fed concentrates in the milking parlour, but, for physiological reasons large quantities of concentrates cannot be consumed in sufficient quantities in the relative short milking time. Therefore, feeder stations, out-of-parlour-feeders (OOPF's), are used where the concentrates can be easily and safely accessed by the cows throughout the day. The animals are identified by an electronic device (transponder), sometimes fixed around their necks, as they enter the computer controlled individual feeders and it dispenses part of their daily ration, if they are due to have some concentrates. The recommended number of animals per station is about 25 - 30. There are several commercial models available, but to protect a cow using a feeder against aggressions the feeder should have a self closing rear gate or a front exit. Unfortunately OOPF's are costly, so, in some cases farmers incorporate the concentrate in a total mixed ration (TMR) rather than use concentrate feeders.

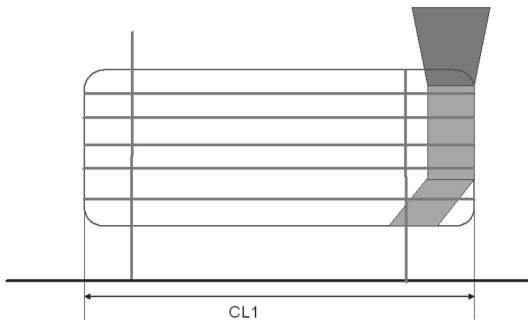

Figure 3.3.8.1: concentrate feeder.

### 3.4 DRINKERS

#### 3.4.1 INTRODUCTION

Water is very important for dairy cows and lack of water will significantly affect milk production, particularly in high yielding cows producing 10,000 litres or more per lactation. Consequently, good quality water must be provided via adequate, reliable and readily accessible drinking facilities. The following gives guidance as to how this might be achieved.

#### 3.4.2 DRINKING WATER REQUIREMENTS

Every day, a dairy cow drinks large quantities of water. How much she drinks depends on various factors such as milk production, average dry-matter content of the feed, stage of lactation and ambient temperature. Castle and Thomas (1975) assume that two of these factors, milk production and dry-matter content of the feed, play a dominant role in determining water intake. They developed the following formula for predicting water requirements (Figure 3.4.2.1):  $y = 2.53x_1 + 0.45x_2 - 15.3 (\pm 8.31)$

where  $y$  = water requirement kg/day  
 $x_1$  = milk production kg/day  
 $x_2$  = dry-matter content of feed %

Calculations using the equation shows that a cow producing 25 kg of milk per day and being given feed containing 40% dry matter has a daily water requirement of approximately 66 kg.

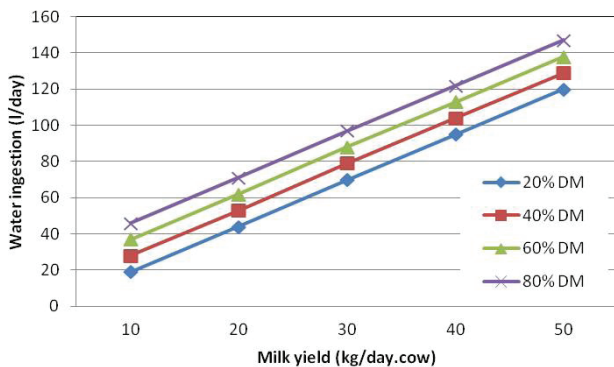

Figure 3.4.2.1: water requirement as a function of milk production and dry matter content of feed [Castle and Thomas, 1975].

However, Meyer (2004), calculates water requirement as a function of milk production, ambient temperature and weight of the animal, according to the following formula:  $\text{Water intake (kg/day)} = -26.12 + 1.516 * \text{average ambient temperature (}^\circ\text{C)} + 1.299 * \text{milk production (kg/day)} + 0.058 * \text{body weight (kg)} + 0.406 * \text{Na intake (g/day)}$ .

Calculations using this equation show that a cow producing 40 kg of milk per day at temperatures above 25°C result in a water requirement of over 100 litres per day.

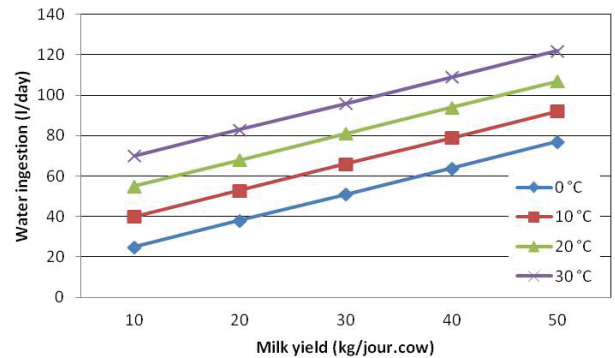

Figure 3.4.2.2: water requirement as a function of milk production and ambient temperature (weight of the cow: 650 kg) [Meyer, 2004].

#### 3.4.3 POSITION OF THE HEAD AND COW BEHAVIOUR

When a cow is drinking naturally (watering place), its muzzle is inserted at between 30 mm and 40 mm into the water and its head is inclined at an angle of between 55° and 75° (Boxberger, 1975) (see Figure 3.4.3.1). This is because bovines are suction drinkers: there should be no influx of air during the drinking process, and the nostrils must at the same time remain free. A minimum water depth of 0.60 - 0.80 m should therefore be adhered to. About 10 litres of water are consumed in each drinking event, which lasts one to two minutes. However, in a natural position, a cow can drink between 18 and 25 litres (max. 25, ALB Bayern 2000) of water per minute. Metzner (1978) suggests that in order for a cow to drink naturally from a drinker (trough or bowl), a water surface area of 0.06 m<sup>2</sup>/cow should be allowed.

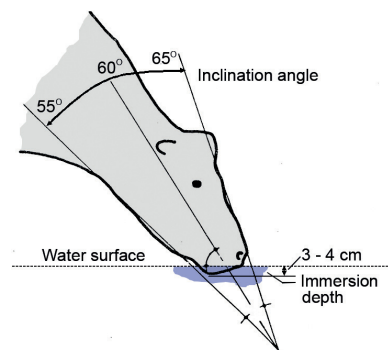

Figure 3.4.3.1: position of the head during drinking.

Tests recording the behaviour during drinking showed that a trough height of 0.60 m and dimensions of 1.39 m x 0.95 m led to markedly longer use of the trough (27.3 sec) with a higher consumption per drinking event than in the case of a smaller trough placed lower down (1.26 x 0.68 m at 0.30 m) (Pinheiro, 2004). This also resulted in a higher total consumption per day (80 litres, grazing and 17% dry-matter content in pasture forage). Cows prefer to drink from a trough, rather than from flowing water or a bowl.

### 3.4.4 WATER QUALITY

Water has a certain smell, colour and taste. Although subjective, these measures can give a good indication of the quality of drinking water. A more accurate assessment of water quality requires the measurement of certain physical, chemical and bacteriological parameters, e.g. suspended solids, pH and biochemical oxygen demand.

The design and maintenance of drinkers will affect the quality of the water. The water in the drinkers may become polluted with faeces, urine, feed, detritus, algae and other organisms that will reduce water quality. Troughs and/or water bowls should be designed so they can be easily emptied and cleaned on a regular basis. The functioning and cleanliness of watering facilities should be checked daily.

About water temperature: cows prefer (drink most water) when the water temperature was +17°C (Andersson, 1984). With water temperatures less than +10°C, the cows yield 0.8 kg less milk per day (Himmel, 1964). Therefore, the ideal temperature for drinking water is between 10°C and 20°C.

### 3.4.5 DRINKING FACILITIES - GENERAL REQUIREMENTS

Any drinker (trough or bowl) should:

- be easily accessible
- be of the correct size
- provide water at the correct height
- allow each animal to consume water at a minimum rate of 10 litres/min
- limit water movement so that cows do not gulp air instead of water.
- be designed so as to prevent fouling with faeces
- be easy to clean.

#### 3.4.5.1 Water troughs

For loose housing systems, water troughs with a minimum usable capacity of about 150 - 200 litres are recommended. The large quantity of water held in the troughs will allow the animals to drink quickly. Even if the water supply flow rate is low, this size of trough will allow cows that may consume up to 20 litres water/minute to drink regularly. A water trough 2.5 m long, 0.4 m wide and 0.4 m deep should be sufficient to satisfy the water requirements of 25 cows. Per cow, a trough length of 0.05 m (winter) and 0.10 m (summer) is suggested. There should always be two troughs available per group of animals, regardless of the size of the group, since, in certain circumstances, a dominant cow may occupy one of the troughs for a fairly long time.

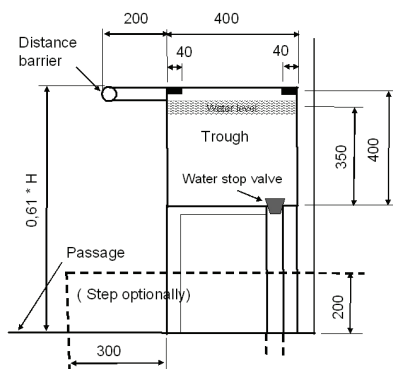

Figure 3.4.5.1.1: cross section of a water trough with a distance barrier (or alternatively with a step).

Troughs should provide the cows with a water level at a height of 0.61 H (normally about 0.85 m) above the floor. The water level should be between 0.07 m - 0.08 m (Alb-Bayern, 2000) below the top of the trough, to avoid excessive spillage and splashing of adjacent areas.

In all cases the water trough should have a water stop valve so that it can be easily emptied, cleaned and maintained. Troughs with a tipping mechanism facilitating cleaning are ideal.

To reduce soiling of water troughs, a guard rail (distance barrier) or step may be used. These and other features are illustrated in Figure 3.4.5.1.1.

#### 3.4.5.2 Water Bowls

Bowl type drinkers should provide a minimum surface area of 0.06 m<sup>2</sup> and a water inlet flow rate of 10 litres/minute. The inlet flow rate should not be restricted by the water supply pipework, or inlet nozzle.

In tied housing stalls, water bowls should be located so that the water level in bowls is at a height of 0.55 H above the floor. This drinking facility is not recommended for loose housing.

Certain drinkers are available, which are a compromise between water bowls and water troughs. Typically they have a large surface area and the inlet flow rate may be up to 20 litres/minute. These drinkers, however, may have some disadvantages that need to be considered when selecting them, e.g. the water may be too shallow or the water flow may appear too turbulent at high inflow rates.

#### 3.4.5.3 "Ball drinker"

Description:

The principle is always the same with different variations. The drinker sits in an insulated tank with water level regulator inside (ball cock). The drinking cow can access the water through an opening, closed with a ball or a cap.

Advantages:

- frost-proof and mechanically simple construction
- little maintenance required
- mostly used in pastures.

Disadvantages:

- hygienically unsatisfactory: the state of cleanliness and difficult to clean
- balls have to be pushed aside. For younger or weaker animals this can be a problem. Access can be restricted in freezing conditions.

### 3.4.6 FREEZING

To prevent freezing, the water supply system and drinker should be protected from frost. This may be done in a variety of ways, some of which might provide the additional benefit of making water available to the cows at a predetermined temperature. To frost-proof underground supply pipes, depending on climatic zone, they should be laid at approximately 0.8 m - 1.2 m deep.

Passive systems using, for example, ground heat (see Figure 3.4.6.1) might be appropriate in some climates. In others,



heating systems using electricity, gas or some other fuel input will be necessary. Ball drinkers are frost-proof and hence often used in outdoor situation.

Among the heating systems that might be used to give frost protection are:

- low voltage direct electric heating of the water in the drinker
- low voltage electric wrap-around heating of supply pipes, valves and the body of the drinker
- continuous circulation of heated water through the drinker/drinkers.

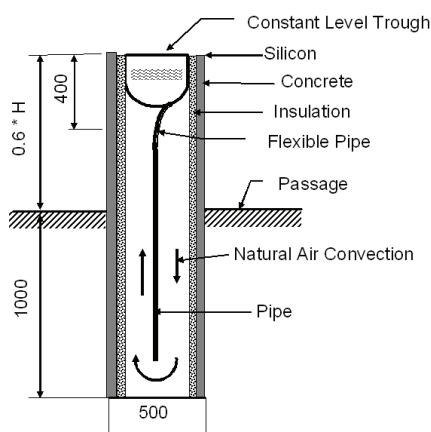

Figure 3.4.6.1: cross section of a anti-frost water trough.

### 3.4.7 ACCESS/LOCATION OF DRINKERS

Troughs 2.00 m to 2.50 m in length and 0.40 m to 0.45 m in width should be located in passages at least 3.50 m wide. When several cows are drinking at the same time this will allow sufficient space for other animals to pass behind them (see Figure 3.4.7.1 and Section 3.4.7.1).

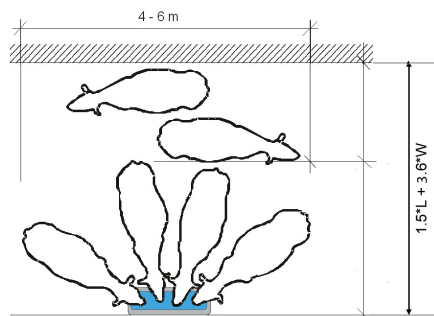

Figure 3.4.7.1: position of a trough in a passage.

In a housing system with both bedded and un-bedded (solid or slatted) floor areas, drinkers should be placed over the un-bedded area. This will avoid wetting of the bedding due to spillage or splashing (see Figure 3.4.7.2).

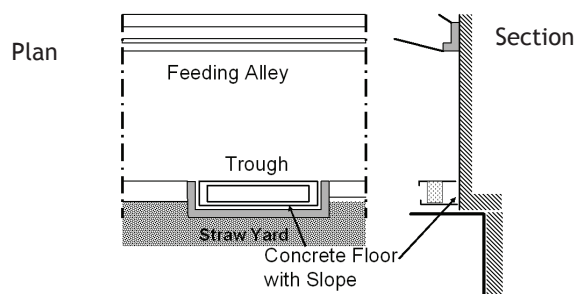

Figure 3.4.7.2: trough in a housing system with littered/bedded area.

### 3.4.8 NUMBER OF BOWLS/DRINKERS

The number of water bowls provided should be equivalent to 15% of the number of dairy cows, i.e. approximately one bowl for every 7 cows. Even in a small herd this can mean that a large number of water bowls are required, e.g. 9 bowls for 60 cows, and it might be difficult to place all bowls in a satisfactory location.

### 3.4.9 TECHNICAL SPECIFICATIONS

See Table 3.4.9.1.

Table 3.4.9.1: a ready reckoner for water flow by different pipes dimensions

Dimension		Maximum water flow rate (litre/min)*											
Standard steel pipe size (inch)**	Plastic pipes (polyethylene) D (mm)	Pipe length (m)						Pipe material					
		10		20		30		40		50		60	
		GS	P	GS	P	GS	P	GS	P	GS	P	GS	P
0.5 "	20	21	33	16	23	14	18	11	15	10	14	9	12
0.75 "	25	43	60	36	40	28	33	24	27	23	24	21	23
1 "	32	96	114	66	78	57	66	45	51	42	48	39	45
1.25 "	40	195	204	144	144	120	114	96	96	90	84	84	84
1.5 "	50	300	375	210	258	180	210	150	174	132	156	129	150
2 "	63	510	660	420	480	330	390	285	330	270	300	240	270

D = outer diameter  
GS = galvanized steel  
P = plastic pipes

\*Initial water pressure 300 kPa, 50 - 70 kPa pressure drop in the pipe

\*\*Internal diameter

\*\*\*External diameter

Example: 32 mm external diameter polyethylene (plastic) pipe of 40 m length gives 51 litre/min.

## 3.5 FLOORING

### 3.5.1 INTRODUCTION

Floor surface provides interface between animal and house and it is of critical importance to the satisfactory performance of the facility as it is the part of the building with which the animal comes into closest and continuous contact. Floors are multifunctional elements and this can lead to some compromises in their design.

The floor must be strong enough to support all the loads from animals and equipment where applicable. Inadequate flooring in walking areas can lead to claw and leg disorders, which is very common, and disturbed natural behaviour by the cow. Surfaces that are too rough can cause abrasions and a rapid wear of animal claws. A surface, which is too slippery or which has too large a slope, can cause injury resulting from falling or reduce the frequency of animal movement so affecting natural behaviour and locomotion. Hard floors can contribute to joint or claw illness like laminitis. In case of slatted floors the gap width should be limited to prevent claw damage. However, efficient drainage will require minimum gap dimensions. Additionally, unsatisfactory hygiene, owing to dirty and wet floor surfaces, can result in increased incidence of diseases like mastitis and infectious digital dermatitis. Consequently, from the animal point of view the floorings should:

- give an appropriate grip but must not be too abrasive
- be sufficiently soft but not too hard
- be kept clean and dry.

Other factors, such as environmental policies, must also be considered e.g. the need to control ammonia emissions from livestock houses is influencing new floor designs in some countries.

### 3.5.2 FLOORING SYSTEMS

Different functional areas can be identified in animal accommodation facilities which include feeding areas, resting areas and cattle traffic routes. Specific floor designs may be selected for these different functional areas, e.g. passages with a slatted concrete floor, a rubber mat covered solid floor in feeding and collecting areas combined with mattresses in cubicles or sand or straw bedded resting areas.

Of the solid floors, those constructed of concrete are the most common with solid walking area floors typically cleaned by mechanical or vehicle scrapers; or in some regions and countries, combined with a flushing system. Mastic asphalt is sometimes used as a concrete floor coating. Rubber mats on slatted or solid concrete floors are becoming a more common walking area surface-floor combination. Pre-cast concrete slats, above a slurry pit or channel, are the most common type of suspended floor design, but pre-cast solid concrete elements, grooved or not, are in use as well. Sometimes mechanical scrapers or cleaning robots are used on slatted floors in order to improve floor cleanliness. Clean flooring in walkways along cubicles improves the cleanliness in the cubicles as well, resulting in lower udder and teat contamination, which may enhance milk quality and reduce mastitis occurrences.

### 3.5.3 STRUCTURAL REQUIREMENTS

When specifying floors for dairy cow houses the designer must take into account a range of factors e.g. the loadings imposed by animals and equipment, the ability to provide

a non-slip surface, regulations for water protection, the method of cleaning to be used, whether bedding material is available etc. The aggressive nature of the environment imposed on the floor surface resulting from the chemical composition of manure and feed residues necessitates extra demands on the quality of materials used. In addition the mechanical impact of cleaning systems can place extra loadings on the structure. In response to the special structural demands placed on floor systems several countries have developed national standards for the specification of floor construction for use in cattle housing. These standards cover issues such as structural detailing and construction practice, reinforcement specification and concrete quality.

### 3.5.4 ANIMAL FLOOR INTERFACE

Many ailments in animals are multi-factorial in nature and the floor can be considered to be amongst the most usual factor contributing to problems with the health of the feet and legs of dairy cattle.

Flooring contributes directly, through its physical properties, or indirectly, for example, by allowing (because of poor cleanness) disease vectors to be harboured on the floor surface. Claw disorders in cattle have been linked with the frequency of contact with faeces and urine, and the floor's ability to cause injury through damage to, or destruction of, the physical structure of tissue. Additionally, bone, muscle and ligament damage can be caused by the animal slipping.

These effects will be primarily related to the important floor characteristics of:

- slip resistance (friction, or slipperiness)
- hardness (or softness)
- abrasiveness
- surface texture (roughness and grooves/pattern)
- surface profile (slope or gradient).

#### 3.5.4.1 Slip resistance

The slip resistance is a function of the friction between the claw and floor surface. Friction coefficient is a number between zero and one, and describes the degree of resistance to solid bodies to slide over each other, the greater the friction coefficient the greater the slip resistance. The required coefficient of friction (i.e. to prevent slipping) for moving cows is dependent on the cow behaviour; i.e. if the animal is walking straight ahead, turning, fleeing (accelerating) or stopping (decelerating) etc, as well as starting from a standing position. The maximum required coefficient of friction, at the push-off stance phase, ranges from 0.3 to 0.85 for various situations (van der Tol et al., 2005). In walking areas, coefficient of friction of about 0.40 is recommended for dry and clean concrete floors, in order to avoid excessive surface abrasiveness. For non-abrasive materials (e.g. soft floors such as rubber floors), a greater coefficient, up to 0.8 or more, is advisable.

A coefficient of friction on concrete floors within this range 0.35 to 0.45 is hard to achieve under practical conditions; the real slip resistance will be dependent on several factors such as the slurry coating on the floor and wearing of the floor material caused, over time, by grinding and polishing action of mechanical cleaning equipment and animal movements. Unfortunately, solid hard floors, such as concrete or mastic asphalt, where slurry is frequently scraped, particularly during dry and warm weather conditions, can become very slippery because of dried slurry on the floor surface. In spite of this, frequent scraping i.e. at least five

or six times a day, particularly where automatic scrapers are used, is generally recommended because scraping lessens the reduction of the coefficient of friction caused by surface slurry build-up as well as enhancing hygiene and reducing ammonia emission. When using mechanical scrapers it is recommended to use plastic or rubber blades to help prevent excessive smoothing of the floor surface.

The coefficient of friction measured in a particular place will depend on the method of measuring. One type of friction measuring device often used is a skid resistant tester (SRT), which can only be used with reliability on hard flooring and not on soft flooring such as rubber. The recommended walking area SRT value, for clean and wet concrete floors, should be in the range 55 to 65.

Practically, an adequate passageway concrete surface finish can be obtained by light brushing of the hardening concrete surface.

Old concrete floors, both solid and slatted, that have become slippery can be reconditioned to provide better slip resistance. Depending on the type of floor, different techniques can be used; such as acid etching, blasting, bush hammering, routing (strip milling), grooving and floor covering (e.g. rubber). The end result, durability and cost-benefit, vary depending on the method used and workmanship. In general for solid floors, routing, grooving and covering are preferable when trying to improve the slip resistance and long term durability of the surface. When routing, creating 3 mm deep grooves, maximum, is recommended. Grooving does not improve friction of the surface between grooves, but can help the claw to get grip, in particular when a foot is sliding. Furthermore, grooving will last longer. Floor covering with rubber (mats) can be recommended because this will enhance slip resistance and give a soft floor. Unfortunately rubber is relatively expensive. However, particularly in herds with claw disorders, the benefit can be considerable. Polyurethane or epoxy resin floor coverings should not be used where mechanical scrapers are used.

#### 3.5.4.2 Abrasiveness

All floors made of conventional materials will be abrasive to some extent. Indeed for most hoofed animals, floors need to be abrasive to some extent to keep the claw in good condition and prevent over growth. On the other hand, floors that are too abrasive can lead to unnatural shape of the claws and abrasion injuries to those parts of the body that come into contact with the floor e.g. in walking areas the claws, in resting areas knees, hocks and teats.

Within reason, the cattle have the ability to adapt to the rate of claw wear, the more wearing the more the claw grows and vice versa. Clearly problems will occur where claw growth does not keep pace with claw wear. Conversely, where claw wear is low, regular foot trimming will be required. Too much wear may also cause lameness and the animal may prove harder to handle. It is also likely that there will be different wear rates when cattle are moved from housing to grazing, and back again.

#### 3.5.4.3 Hardness

The hardness of floor materials may be unavoidable if they are to perform functions such as load bearing, resistance to corrosion and damage, while being practical and economic in use. However, cattle prefer to stand and walk on softer surfaces rather than concrete floors. The incidence of non-

infectious digital disorders can be reduced and behaviour can be improved where cows are accommodated on softer surfaces. Covering slats and solid hard floors with materials that provide a soft contact surface, such as resilient rubber mats or coatings, can improve the animals natural behaviour and welfare, and may result in increased profitability. Slatted floors, especially hard floors with great void ratios and wide gaps, can increase the pressure on the feet causing claw injuries.

#### 3.5.4.4 Surface texture - Roughness

Surface texture of floors is a complex measure that dictates its anti-skid performance and includes micro-roughness as well as macro-roughness.

Micro-roughness provides a safe frictional connection between the claw and the surface. It is reduced over time but these effects can be counteracted by using concretes with greater strength incorporating coarse and fine aggregates, as well as by applying 'shake-on' toppings of crushed aggregates that are resistant to polishing.

Adequate roughness is necessary to establish a safe frictional connection between the claws and the floor when the surface is soiled or wet. On smooth wet surfaces, a film of liquid (slurry or water) may lie on the surface and the claw cannot come into contact with the floor so slipping occurs. These effects are analogous with smooth tyres and aquaplaning in a motor car. If the surface has a texture or dense grooves that allow this liquid film to be squeezed away, rapidly, then the claw will come into contact with the floor before a slip occurs. This is analogous to the tread in a car tyre.

#### 3.5.4.5 Surface profile - Slope or gradient of the floor

Slope will have an obvious effect on drainage from the floor, on floor cleanliness and on the comfort of animals standing, walking and lying. Steep slopes will obviously allow liquids to drain rapidly and might prove an aid to cleanliness, by ensuring that soiled bedding "flows" down the slope. However animals may not be able to stand, walk or lie comfortably on steep slopes.

Floor slopes in passageways should not exceed 1:40 (2.5%). In pens where animals are lying the slope used will depend on the type of bedding and manure management system utilised. Sloped floor systems, which rely on the movement of animals to transfer soiled bedding to the manure collection area, are not recommended for dairy cows. However, for young stock, sloped floor systems can be used and slopes of between 8% and 10% are required; the greater slope is recommended when the pen is more than 5 m deep (i.e. distance parallel with the slope). In facilities where straw remains in the pen, a slope of 1:20 (5%) will ensure excess liquid is drained to appropriate channels.

Slats or slat units at different levels can cause excessive point forces on the animal's sole. Therefore, it is important that individual slats or slats cast in groups are placed evenly and level. This is achieved more easily with slats cast in groups, so this form of slat construction is preferred.

### 3.5.4.6 Cleanliness, health and ammonia emission

Proper liquid drainage and cleaning management of walking areas is of considerable importance for good hygiene and, indirectly, for good claw and udder health. It is also a way of reducing ammonia emissions from walking areas. Other methods that can be employed to reduce ammonia emission are:

- Liquid draining floors, e.g. solid floor sloped toward appropriate channels, “Dutch grooved floor system” (see Section 3.5.5.5)
- Scraping passages, with solid as well as slatted floors, at least five or six times a day
- Washing down the floors with water (efficient but expensive)
- Remove the slurry frequently from the channel underneath suspended floors
- Chill the slurry in slurry tanks and channels
- Adding acid (e.g. sulphuric acid) to the slurry pit

### 3.5.5 FLOOR MATERIALS AND FLOOR TYPES

All materials used in the construction of floors should be non-toxic to cattle and be resistant to, or protected against:

- chemical attack and deterioration
- climatic conditions, e.g. extremes of temperature, frost, solar radiation
- effects of pressure washers, etc.
- effects of gnawing, digging or other animal behaviours.

#### 3.5.5.1 Solid concrete floors

Concrete used for floors in cattle houses must be designed to cope with the loads imposed by the animals and vehicles that are used during feeding and cleaning operations. The surfaces must be resistant to mechanical damage (abrasion, chipping etc.) and chemical attack (manure, feed residues, cleaning chemicals and disinfectants). The floor must provide an impermeable barrier to ensure the safe collection of any effluents produced.

There are various national standards regarding the specification of concretes for use in the floors of cattle buildings. The standards usually have different specifications due to floor load and areas; such as feeding area, walking areas and lying areas. Adequate concrete quality in feeding (including construction of the feeding table) and walking areas, is 28 day cube strength of 40 MPa and water/cement ratio of the fresh concrete less than 0.50. In laying areas, e.g. in cubicles, the concrete quality can sometimes be less, for instance a cube strength of 30 MPa and water/cement ratio of 0.55.

Where the concrete may come in contact with silage effluent, aggregate should be crystalline and contain no limestone. For constructions that may be exposed to frost, e.g. in uninsulated buildings in a severe climate, the percentage of air entrained in the fresh concrete should typically be 6 %. The concrete floor should be provided with mesh, or equivalent, reinforcement and appropriate movement joints (expansion and contraction) in accordance with national standards. Floors in areas used by vehicles should not be less than 150 mm thick. Where access is limited to animals alone, this can be reduced to 100 mm minimum, but this would not be a general recommendation as the use of the floor may change.

#### 3.5.5.1.1 Grooves

In order to provide slip resistance for cattle walking in all directions, grooves can be formed in the solid concrete. For instance a diamond pattern at an angle of 60/120 degrees (shown below) with grooves 10 mm wide and at least 6 mm deep with a distance of 80 mm apart, can grasp the claw when sliding or it is about to slide. On the other hand, grooves can make the floor surface cleaning by scrapers more difficult. Preferably, the grooves should be cut or milled in cast-in-situ concrete when the concrete has hardened. The grooves should not exhibit sharp edged transitions.

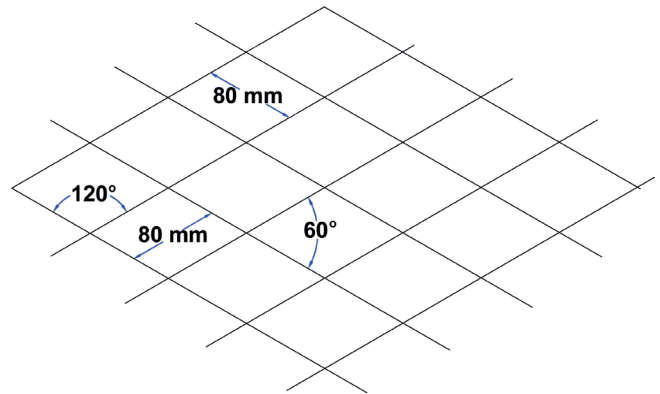

Figure 3.5.5.1.1.1: grooves in diamond pattern.

Making impressions in fresh concrete will often lead to irregularities, burrs and a convex surface between the grooves, which increase the risk for claw injuries and digital disorders and are not recommended.

#### 3.5.5.2 Mastic asphalt floors

Asphalt is a mixture of bitumen and ballast (coarse material and aggregate of different particle size). Mastic asphalt is a type of asphalt where the aggregate is enclosed entirely in the bitumen, resulting in a pore-free and impermeable flooring. The skid resistance of mastic asphalt is long lasting when compared with concrete surfaces and performs well in clean and damp conditions.

Mastic asphalt does not require any compaction and can be used on different function areas, such as stalls and passageways. In loose housing systems the use is normally in walking areas. It can be used in new as well as in old buildings with existing worn concrete floors. However, on mastic asphalt floors, increased abrasion of claws can occur with increasing floor age. Do not use mastic asphalt floors in external, open, sunny positions or in hot climates.

Normally, mastic asphalt floors are cast onto a solid concrete floor with a specific glass-fibre fabric in between. The asphalt layer is usually 30 mm thick, with a maximum aggregate size of 8 mm. The material used should be acid resistant and lime free ballast. Bitumen content and type i.e. viscosity can vary. In a cold environment the viscosity should be greater than in a warm environment to avoid cracking. Also, using a hard polymer modified bitumen, type E, increases the chemical stability. A grain size of 2/4 is recommended when used with crushed aggregates with added round aggregates (approximately 20 %). A surface finish of round-granular sand (sea or natural sand) with grain size 0.4-0.8 mm can be floated on it. Mastic asphalt flooring can be made without any joints even when large floor areas are required. However, because of shrinkage during cooling, the use of hot-poured liquid sealants at the

joints with building elements, fittings and fixtures is recommended. The application of hot mastic asphalt is a skilled operation and specialist contractors should be employed.

### 3.5.5.3 Rubber floors

To improve the animal floor interface (see Section 3.5.4.3), and to get appropriate slip resistance, resilient rubber can be used as surface material in the form of mats or as a coating. When assembling, the possibility of expansion due to temperature differences should be considered. To avoid animals in loose housing systems lying down in passages, the resting area should be more comfortable than the passages, e.g. the mats in passageways should be harder than mats or mattresses in the cubicles. There are specific mats for walking areas on the market, both for solid and for slatted floors. Besides cubicles, it is possible to use rubber floors in areas such as passages to the milking parlour, collecting yard, holding lanes and feeding areas. However, using more abrasive floor materials elsewhere, for instance, in outdoor exercise yard or in cubicle passages, may prevent potential problems with claw over growth. Nowadays, mats of rubber mixed with wearing material enhancing claw wear are commercially available. Note: where a manure scraper is used on resilient rubber floors it must be modified to reduce wear and damage.

### 3.5.5.4 Slatted floors

Slat design has improved over time, with modern facilities using multi-rib or “gang” slats rather than the single or twin slats that were used in the past. The resulting floors are more uniformly level and potentially provide a better surface in terms of comfort for the animal. The length of slatted elements provided by manufacturers has increased over time and units are now available up to 4.8 m or longer. There are variations within the range of slat types produced by different manufacturers in terms of gap dimension and void ratio and this will also influence the comfort aspect of the animal floor interface, as well as the drainage characteristics and eventual cleanliness of the animal. The later is also influenced by feed type and the ventilation system used in the building. The table below shows the recommended dimensions for dairy cattle floors.

*Table 3.5.5.4.1: recommended dimensions of slatted floors (without scrapers) for dairy cattle. Note the preferred void ratio is valid for single slats or for elements when calculating the areas between beams as slots. When including the bridges as solid, the preferred void-ratio should be reduced by about one fifth (minus 20%, i.e. preferred void ratio is effectively reduced to 15 - 20 %)*

Type of animal	Preferred width (l) (mm)	Preferred spacing (S) (mm)	Preferred void ratio (%)
Calves and young stock < 400 kg	70-120	20-25	18-25
Heifers and cows > 400 kg	80-160	25-35	18-25

The definition of the terms used in the table are:

Preferred Width (l)	the width of a single slat or solid portion between voids in multi-rib slats (a panel consisting of parallel slats).
Spacing (S)	the clear distance between solid portions of slats. The minimum and maximum figures in the range shown, indicated the shortest and longest distances (measured across any shape of void).
Void Ratio (%)	the unobstructed floor area through which waste can pass expressed as a percentage of the total floor area.

With regard to lactating dairy cows (i.e. increased excreta water content) the spacing between the slats is the most important parameter to increase the drainage capacity. In the table, a spacing of between 25 - 35 mm is recommended, the greater the void ratio the better the drainage capacity. However, in respect of the animal floor interface, the smaller the spacing the better it is for animal claw comfort. This means at the chosen void ratio both narrow slats and slots are preferred. For instance at chosen void ratio of 25 % (excluding bridges of slatted floor elements) for large drainage capacity, a rib/gap ratio of 90/30 mm is preferred to a rib/gap ratio of 120/40 mm. In the case of young stock and dry cows, or when using a lot of bedding materials in resting areas, both the void ratio and the spacing have significant influence on the drainage capacity.

It is an increasingly frequent practice to use mechanical scrapers on slatted floors, in particular in passages between cubicles. In such cases the dimensions of the slatted floor should be different to those shown in the table, i.e. wider ribs, smaller spacing and lower void ratio. In order to avoid problems with the manure scraper, the scraper blades are usually diagonal (5°) relative to the slots.

The use of fully slatted concrete floors for certain animals is restricted or not recommended in some animal welfare codes, e.g. totally slatted floors should not be used for calving cows, cows with young calves or calves of less than 4 weeks of age.

### 3.5.5.5 Dutch grooved floor system

Concerns regarding the emission of ammonia from cattle buildings have led to the development of some novel floor systems. One such design - “grooved floor system” has been developed in The Netherlands and is used at present for walking areas in dairy cow facilities. The grooved floor system consists of solid, level pre-cast concrete elements covering a manure pit. The floor is scraped with a mechanical scraper. The top surface of the floor consists of a series of parallel grooves 35 mm wide and 30 mm deep and placed at 160 mm centre to centre. The width of the solid flat area (i.e. area between the grooves) is 125 mm which is similar to the rib width of a slatted floor. The floor elements are 1.1 m long and the adjacent edges of the abutted elements are tapered which forms a self-discharging perforation at the base of the grooves for the urine deposited on the floor (total area of perforations is < 0.5% of floor area). Faeces are removed by a mechanical scraper to an opening at the end of the passageway. To ensure the grooves remain clean and to prevent the perforations becoming clogged, the blade

of the scraper is fitted with a tooth shaped rubber strip. However, the Dutch grooved floor system does not improve the animal floor interface when compared with scraped traditional slatted concrete floors. Pre-fabricated rubber coating between the grooves instead of concrete is however a development used, for example, in Denmark in order to provide a softer footing.



Figure 3.5.5.5.1: dutch grooved floor system.

### 3.5.5.6 Floor material comparisons

All floor materials have different advantages and disadvantages and when decision making, weighing the pros and cons of each can be difficult. Hence the table below may help when selecting appropriate floor materials and the resulting characteristics.

Table 3.5.5.6.1: relative estimate of floor material characteristics

	Slip resistance	Softness	Abrasive-ness	Durability
Concrete	*		**	****
Mastic asphalt	***		***	***
Rubber	****	****		*

The more \*'s, the greater the degree of the particular characteristic. Maximum is five \*'s. None of them means principally no degree at all of the particular characteristic.

## 3.6 MILKING FACILITIES

### 3.6.1 INTRODUCTION

A milking centre consists of a milking parlour, for the milking operation; a collecting yard, to assemble the group of cows to be milked; and areas dedicated to other equipment, personnel needs and environmental control. A milking parlour is the primary component of the milking centre. Animal welfare, elimination of interruptions to work and unergonomic working positions, as well as faster milking while maintaining milk quality, are major issues.

But a milking centre is more than just a place to milk cows.

Cows are observed during milking. Information needed for management may be collected by visual observations or electronic devices. Cows may be sorted for various purposes before milking or as they leave the parlour. Handling and treatment facilities may be provided. Auxiliary areas in the milking centre may be dedicated to a variety of uses. In fact, the milking centre is the major management hub of the dairy farm and plays an important role in implementing the farm management programme.

Consequently, decisions related to milking centre layout and construction are more than just decisions related to milking parlour selection and design. In fact, a milking centre is an integral component of the facilities on a dairy farm and is a key element in the buildings and equipment, which comprise the tools that allow the dairy farmer to carry out the essential aspects of a management plan and to provide an animal-friendly environment. Thorough planning is essential to ensure that all the components are workable and economically feasible and that they contribute to the management plan of the farm. Of special interest is the correct position of a milking installation in the building, assuring easy handling of equipment, efficient flows and fast but quiet cow traffic.

As tied stall housing is greatly declining in significance, particularly in the case of new buildings, the building requirements for milking in them will not be discussed here.

### 3.6.2 ELEMENTS OF A MILKING FACILITY

A milking centre is a complex facility comprising various components that have to interact efficiently. Smooth operation depends on correct layout, sizing and arrangement (Figure 3.6.2.1):

- collecting yard
- entrance, pre-selection (AMS) and identification
- milking facility:
  - milking parlour
  - cleaning facilities
  - mechanical equipment (vacuum pump, etc.)
- exit, possibly with post-selection, additional facilities (weighing, footbath)
- selection and treatment area (vet, calving, etc.): crush, management rail
- working chutes
- office with herd management
- annex rooms (equipment e.g. vacuum pump, storage, toilet, etc.)
- milk room (bulk tank, cleaning facilities)

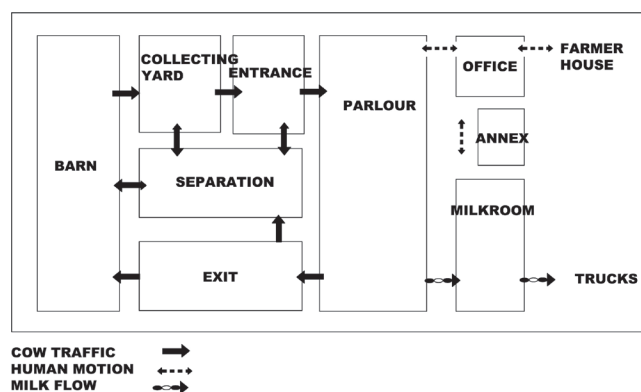
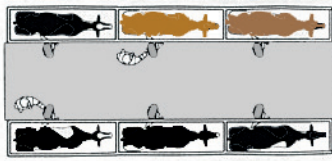

Figure 3.6.2.1: schematic view of the components of a milking centre.

### 3.6.3 MILKING PARLOURS

The milking parlour type and size is important, not only in the context of the overall farm operation, but also in the design and layout of the milking centre.

#### 3.6.3.1 Individual stalls (tandem parlour, auto tandem parlour)



Side-opening parlours have the advantage of individual cow handling and high performance per milking point. However, there is a greater distance between udders compared with the herringbone or parallel parlour. This is an important consideration in more mechanized parlours. As mechanization is added to a parlour, more stalls are needed in the parlour to keep the operator and the equipment busy, resulting in an excessively long pit. Automating the entry and exit system (auto tandem), thus making work easier for the operator and boosting milking efficiency, is possible but expensive. Because of the high space requirement of individual stalls, any expansion will be limited.

#### 3.6.3.2 Herringbone stalls

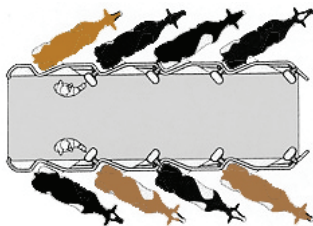

Herringbone parlours remain popular because of their low cost and good performance. They often range from double 4 to double 12, although larger herringbones e.g. double 20 and larger, are used on some dairy farms. Herringbone stalls are adaptable to mechanization. When mechanization is added to the parlour, e.g. automation of the entry and exit gates, more stalls can be added increasing the productivity of the operator. However, this should not result in a very long pit. A slow-milking cow, holding up an entire batch, can seriously affect cow throughput in larger herringbones. Slow-milking cows may be culled or may be segregated in a group by themselves to be milked separately. Herringbone parlours can easily be expanded provided sufficient space is available or allowed for in the design stage.

#### 3.6.3.3 Rapid Exit stalls

With rapid exit stalls, all the cows in a group move directly out of the milking stalls via individual gates or by removing the barrier in front of the cows (see Figure 3.6.4.1.4 - Figure 3.6.4.1.5). The resulting benefit of decreasing overall exit time can be justified for larger parlours, say double 10 herringbones or parallel and larger. However, the building has to be significantly wider to accommodate cow exit routes. In parlours with the rapid exit feature, cow exits should lead to return lanes on both sides of the parlour. Thus, provision for sorting and treating cows, if included, may need to be duplicated on both sides.

#### 3.6.3.4 Parallel (side by side) stalls

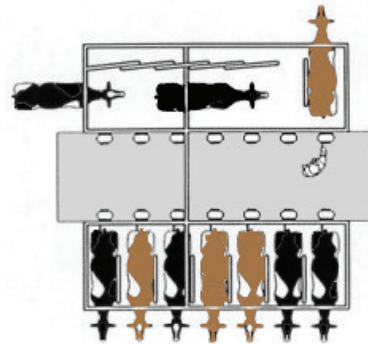

Parallel parlours are a more recent introduction, ranging in size from double 6 to double 40 and larger. Cows stand parallel to each other i.e. at 90° to the operator's pit, requiring the operator to attach teat cups from the rear by reaching between the hind legs. Cows are physically separated from one another by dividers, actuated as individual cows enter. The advantage of the side by side parlour is the rapid exit. However, as with herringbone stalls, a slow milking cow can hold up an entire side.

#### 3.6.3.5 Rotary parlour

Rotary parlours are for medium to large dairy herds and milk producers who require high throughput performance. There are two different types of rotary parlour, according to the entrance route:

- herringbone/tandem position: the cow has to turn on entry to achieve a herringbone or tandem position. The operator works inside the rotating platform (Figure 3.6.3.5.1)
- radial position: the cow stands with its head facing into the centre of the parlour. The operator is on the outside. This arrangement makes entry easier for the cows, and this is reflected in somewhat higher throughput performance.

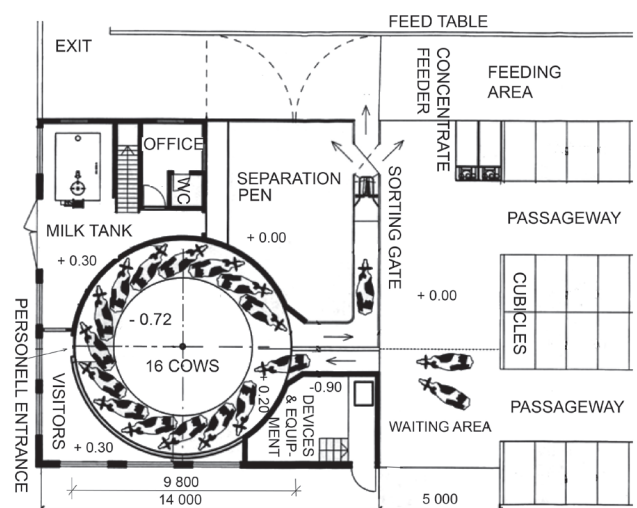

Figure 3.6.3.5.1: example of a rotary parlour with cows taking up a herringbone position and a central operator location. The diameter of the parlour depends on the position of the animals and the number of the stalls. As can be seen, the residual areas outside the rotary parlour can be used for various associated needs (tank room, separation, etc.).

### 3.6.4 DESIGN OF PARLOUR SURROUNDINGS

#### 3.6.4.1 Dimensions

The parlour dimensions depend on the type and number of places provided. Dimensioning should take account of ease of access and exit for the cow, keeping the cow in the correct position for milking and a logical working routine. The following descriptions give examples of the approximate space needed for milking parlours.

##### Herringbone parlour

Length depends on the number of milking stalls. Different designs allow for cow presentation to the pit (operator) to be at different angles (e.g. 30°, 50° or 90°), which will affect the overall length and width of the parlour. Exit space required depends on the type of exit (i.e. to the side or straight ahead). In larger parlours with two and more operators, the working passage (pit) should be enlarged accordingly (Figure 3.6.4.1.1 - Figure 3.6.4.1.2).

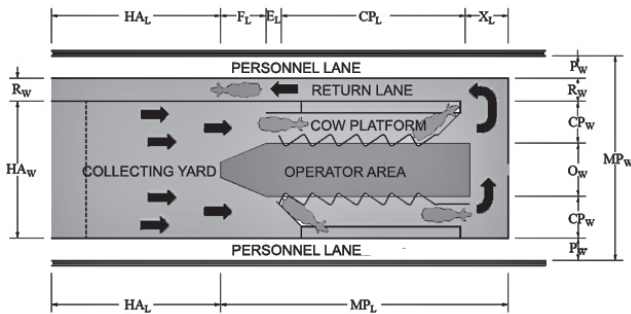

Figure 3.6.4.1.1: herringbone milking parlour, standard exit and one return lane (after DPC 54 Milking Parlor guideline, 2014):

- $MP_W$  = total milking parlour width:  $2P_W + R_W + 2CP_W + O_W$
- $P_W$  = personnel lane/race width: 70 - 90 cm
- $R_W$  = return lane/race width: 80 - 100 cm
- $CP_W$  = cow platform width: 150 - 185 cm
- $O_W$  = operator platform (pit) width: 185 - 245 cm
- $MP_L$  = total milking parlour length:  $F_L + E_L + CP_L + X_L$
- $F_L$  = length of entrance funnel area: 245 - 365 cm
- $E_L$  = entrance area length: 60 cm
- $CP_L$  = cow platform length: 90 - 115 cm per milking stall + 105 - 190 cm (depending on stall manufacturer)
- $X_L$  = length of exit turning area: 120 - 165 cm
- $HA_W$  = collecting yard (holding area) width: 490 - 620 cm
- $HA_L$  = holding area length is related to number of cows to be held and holding area width (allow 1.4 m<sup>2</sup> per cow)

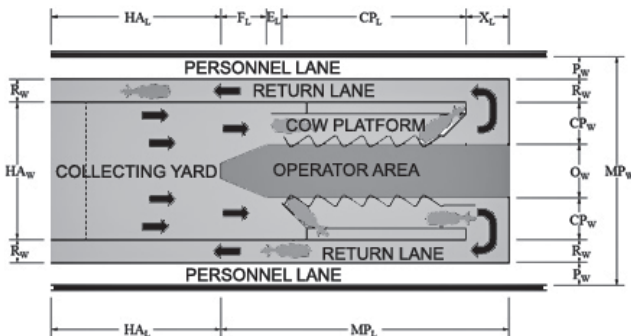

Figure 3.6.4.1.2: herringbone milking parlour, standard exit and two return lanes (after DPC 54 Milking Parlor guideline, 2014):

- $MP_W$  = total milking parlour width:  $2P_W + 2R_W + 2CP_W + O_W$
- Width and length of the parlour correspond to measurements given in Figure 3.6.4.1.1.

##### Parallel parlour

Length depends on the number of milking stalls. The width depends on exit area; and number and width of return lanes. (Figure 3.6.4.1.3 - Figure 3.6.4.1.5).

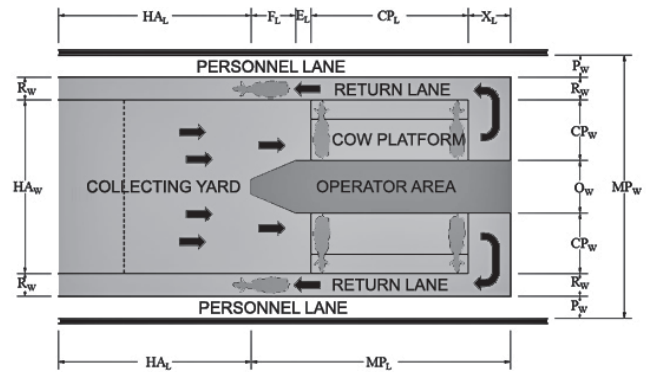

Figure 3.6.4.1.3: parallel milking parlour, standard exit and two return lane (after DPC 54):

$MP_W$  = total milking parlour width:  $2P_W + 2R_W + 2CP_W + O_W$   
Width and length of the parlour correspond to measurements given in Figure 3.6.4.1.1. except:

- $CP_W$  = cow platform width: 245 cm
- $F_L$  = length of entrance funnel area: 305 - 365 cm
- $CP_L$  = cow platform length: 70 - 75 cm per milking stall (depending on stall manufacturer)
- $HA_W$  = collecting yard (holding area) width: 670 - 740 cm

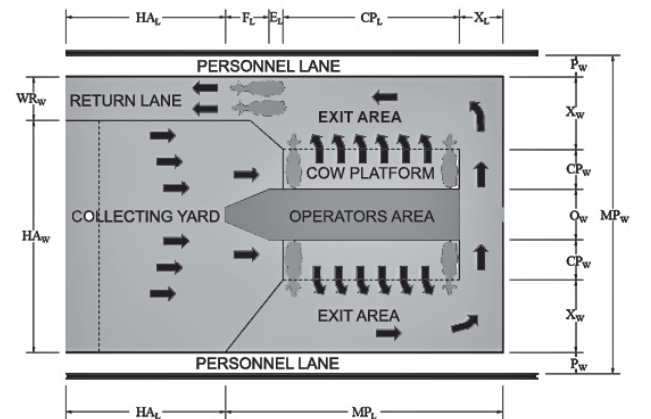

Figure 3.6.4.1.4: parallel milking parlour, rapid exit and one wide return lane (after DPC 54):

$MP_W$  = total milking parlour width:  $2P_W + 2X_W + 2CP_W + O_W$   
Width and length of the parlour correspond to measurements given in Figure 3.6.4.1.3 except:

- $CP_W$  = cow platform width: 180 - 200 cm
- $WR_W$  = wide return lane width: 160 - 200 cm
- $X_W$  = exit area width: > 300 cm

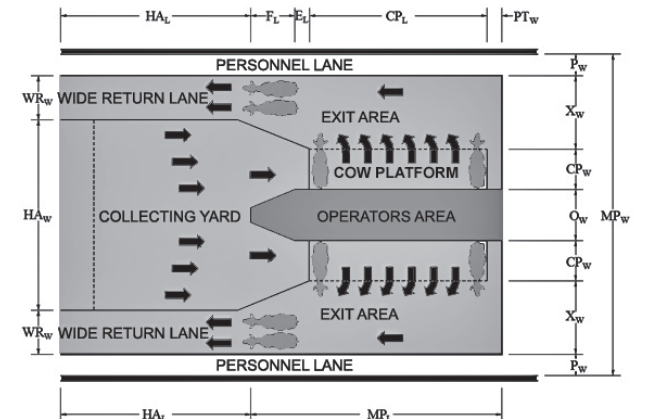

Figure 3.6.4.1.5: parallel milking parlour, rapid exit and two wide return lane (measurements above)(after DPC 54).



### 3.6.4.2 Mechanization

Milking parlour mechanization depends on parlour size, available labour, initial investment and personal preference. Automatic cluster removers (ACR), are considered standard equipment in most parlours now-a-days. Other aspects of mechanization to be considered include crowd (backing) gates and power operated entrance and exit gates.

### 3.6.4.3 Arrangement and equipment

In general, static milking parlours are located in a separate building from the cow housing. This cuts down potential for pollution of the milking equipment by dust, micro-organisms and smells from the housing area and helps protect equipment from effects of weather (particularly frost). Also working conditions are better in a separate area.

Milking parlours have to be provided with acid-resistant, non-slip flooring in the animal and operator area. The cow standing area should have a slight gradient, of 2%, directed away from the operating area and a floor level inlet to facilitate cleaning of the area by hosing down or using a high pressure cleaner.

Appropriately sized and moisture proof light fittings are necessary to illuminate the working area with a minimum of 200 lux in general areas and up to 500 lux in the pit. The lighting should be arranged so that the udders are not in shadow.

Moisture given off by the animals and washing water make for high air humidity in milking parlours. Effective ventilation, if necessary forced ventilation, should be ensured especially in summer. The floor area for the operator should be heated in winter in cold climates. The temperature in the milking parlour, dairy and plant room must avoid frost.

The walls should be covered with material that is hygienic and makes them easy to clean, e.g. high quality paint system, PVC-sheet or ceramic tiles etc.

### 3.6.4.4 Design factors affecting parlour performance

**Parlour type and size:** Milking parlours are available in various types and sizes. Parlour size is dependent on herd size, milk yield, number of cows etc. A large range of helpful information is available from advisory services. Parlour type influences building size, cow traffic to and from the parlour, milking routines and degree of mechanization.

**Cow Entrance:** Size and layout of the collecting yard affects cow entry time. Holding times of more than one hour per milking must be avoided in today's higher producing herds. Cows should enter the parlour straight ahead. Turning at the entrance can slow cow movement, interrupting the operator. If cows must be turned, it should be done at the exit rather than at the entrance. The holding pen should be as open to the parlour as regulations allow, with good lighting between the pen and the parlour.

**Cow exit:** Lighting in the exit alley should be bright and uniform. Cows do not like the contrast of crossing from a well lit parlour platform to a dark exit alley. A rapid-exit lane of at least 2.40 m is adequate for cows to move forward and turn towards the resting and feeding area. An alley that is too narrow will not allow the cows sufficient room to clear from under the raised front of the stalls; whereas, alleys that are too wide may allow cows to stand in the lane without turning to leave the parlour.

### 3.6.5 PARLOUR ENTRANCE AND EXIT: COLLECTING YARDS

Voluntary and unassisted cow movement is desired for good efficiency in the milking operation. Problems with cow entrance and exit consume operator time as well as interrupting the operator's routine.

Avoid steps or steep ramps (more than 10%) before a parlour entrance. If regulations require a step, it should be kept below 200 mm in height.

Doors and walls at the parlour entrance and exit hinder cow movement. A ramp that extends the operator's pit a distance of between 3.0 m and 3.5 m into the collecting yard will allow the operator to get behind difficult cows without chasing them away from the parlour entrance. The ramp will need to be fenced on either side. Tapering the fence down to around 300 mm wide allows the operator to pass through and also serves to provide a funnel entrance to the parlour. Gates added along the sides of the ramp can be used to direct different groups of cows to different sides of the parlour. These gates can also be used to close off access to the parlour.

For the collecting yard; allow 1.4 - 2.0 m<sup>2</sup>/cow. The floor surface should preferably slope at between 2 - 5% away from the parlour. In hot climates, a cooling system (fans etc.) can be very useful. Pushing systems in the collecting yard (backing or crowd gates) may help improve parlour throughput. Parlour feeding may improve cow entry, but hinders cow exit. Parlour feeding is not recommended since cows do not spend enough time in the parlour to consume the feed needed for high milk production. If grain is fed to improve cow entrance, feed the same amount to each cow, about 1.5 - 2.0 kg. Available equipment allows a fixed amount of feed to be dispensed to each cow.

Provide return lanes from the parlour to the housing unit. A single return lane, where one group of cows crosses over the front of the parlour to exit, is common when sorting, handling, restraint and treatment areas are provided in the milking centre. In double-8 and larger herringbone parlours, exiting of cows is improved by having two return lanes, side-by-side.

Lanes should be one-way passages. Lanes can be hosed down or hand scraped. Return lanes outside the building, which are less common, can be wide enough to scrape with a tractor.

The width of return lanes for parlours with rapid exit stalls and parallel parlours should be at least 2.5 m and are generally 3.0 m. If cows are to be sorted while exiting the milking centre, these wider lanes should be narrowed to one-way passage width for that purpose.

To reduce soiling of the wall surface, rub rails may be attached to walls running along the side of a lane. Mount rub rails about 0.65 \* H high, positioned so as to keep cows at least 10 cm away from the wall.

### 3.6.6 OTHER AREAS

Besides a milking parlour and collecting yard, a milking centre may include a milk room, a utility or machine room, a storage area, a lounge area for personnel, an office, a toilet and an animal handling and treatment area (see also Figure 3.6.4.1.3).

The milk room may contain the bulk tank (or access ports

of a bulk-headed tank), a milk receiving assembly, inline cooling equipment and facilities for cleaning, sanitizing and storing milking equipment. Size the milk room to allow for future expansion of milk storage capacity. The milk room should be located in the least sunny area with good access for the milk collecting tanker.

The utility room houses the mechanical equipment associated with the milking system (vacuum pump, pulsator controllers), the system for cooling the milk (condensing units, heat exchangers) and related equipment. In addition, the utility room can house water heaters and a heat exchanger to heat water and the rest of the milking centre. Provide a large access opening or overhead door directly to the outside to facilitate equipment replacement.

Provide a separate room for storing cleaning compounds and supplies, spare parts, medical supplies and similar products. National regulations may require separate, clearly labelled storage areas for medication for use in lactating and non-lactating cows.

The personnel area includes toilet facilities as well as lockers, showers, washing facilities and a lunch and resting area. An office should be provided for storing the records associated with day-to-day management of the herd (milk production, breeding, veterinary), and other farm records and files.

Sorting, handling, restraint and treatment of animals is often incorporated into the milking centre. Each room or area must be given special attention and careful thought based on the functions to be served, spatial arrangements and relationship to the overall milking centre.

### 3.6.7 SPECIAL REQUIREMENTS OF AN AUTOMATIC MILKING SYSTEM (AMS)

#### 3.6.7.1 Systems

There are two different systems: single-stall and multiple stall. Single-stall systems are recommended for groups of 50 to 60 lactating cows; two-stall systems for up to 90 and three-stall systems for up to 120. Greater numbers of stalls have not proved practical, as the cow traffic creates bottlenecks at the entrance. However, in 2010 DeLaval developed a fully automatic rotary parlour, which incorporated AMS robotic units in an attempt to speed up milking and increase cow flow; and makes big groups of cows possible.

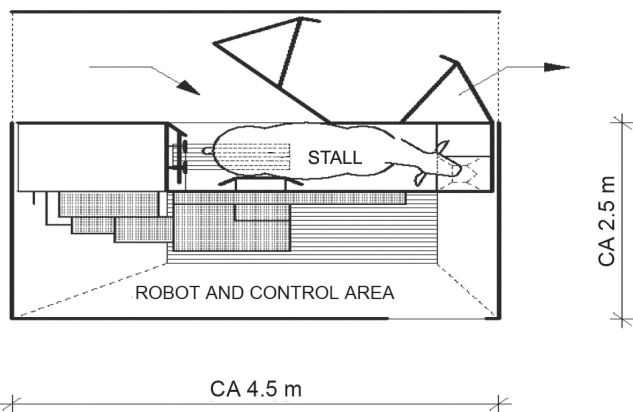

Figure 3.6.7.1.1: single-stall system, space requirement 16-22 m<sup>2</sup>, with entrances and exits and a control room. (The exact dimensions depend on the manufacturer).

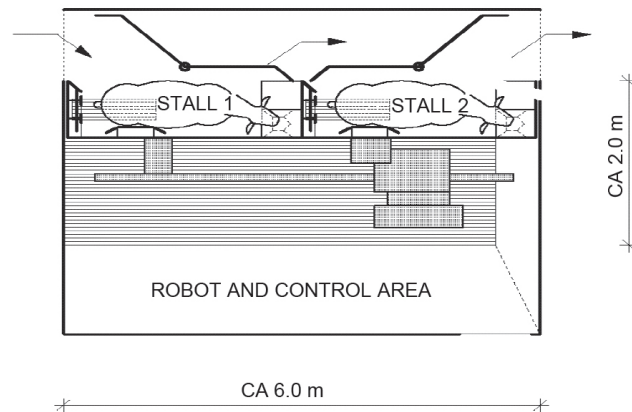

Figure 3.6.7.1.2: two-stall system, space requirement 33-44 m<sup>2</sup>. The layout plan does not include head-end service facilities (control, cleaning), as these depend very much on the manufacturer.

#### 3.6.7.2 Cow traffic and stall design

Cows are encouraged to enter the AMS either to consume food at a feeding area beyond the AMS or to use the robot. A distinction is made between free and controlled cow traffic. The nature of the cow traffic essentially determines the stall design. Controlled cow traffic means less driving work for the operator, but on the other hand access to the feeding area is restricted. Efficiency of operation is increased with selective controlled cow traffic, where “intelligent” electronic entrance gates allow direct access to the feeding area. This is also the most expensive solution, though. The layout of the passages and gates must be designed so that low ranking cows have easy access to the feeding and milking area. As there is continuous access to the feeding area round the clock, it is not essential to provide a feeding place for each animal. What matters is that feed should be available for most of the day.

##### Free cow traffic

The cow is free to choose whether to enter the AMS, the feeding area or the lying area. The stall design is relatively unaffected. This solution is therefore also suitable when converting buildings. The AMS location must be attractive to the cow, i.e. readily accessible.

##### Controlled or selectively controlled cow traffic

With such systems, partitions, lanes and one-way or control gates are used to direct the cow traffic. Before entering the feeding area each cow has to pass through the AMS, where milking authorisation is checked by pre-selection. This type of system works best in cubicle systems with two or four-row cubicles (Figure 3.6.7.2.1). In selectively guided cow traffic the animals can enter the feeding area directly via electronic entrance gates if they are not scheduled for milking.

#### 3.6.7.3 Separation pen

When using an AMS it is advisable to provide a separation pen. Post-selection enables cows that have not been milked and any cows requiring treatment to be separated. The separation pen should be provided with lying areas and a supply of water and feed for longer-term occupancy.

### 3.6.7.4 Milk storage and cleaning

Transporting the milk from the AMS to the bulk tank requires some special measures for quality reasons:

- pipe routes should be kept short, i.e. milk tank should be located near the AMS.
- pipes should be insulated in order to prevent frosting.

Extra space should be allowed in the dairy for a buffer tank (reserve storage to cover the interruption during milk pumping to the milk tanker and subsequent cleaning of the storage tank).

When considering the size of slurry storage, it should be borne in mind that cleaning of the AMS produces a greater volume of washing water.

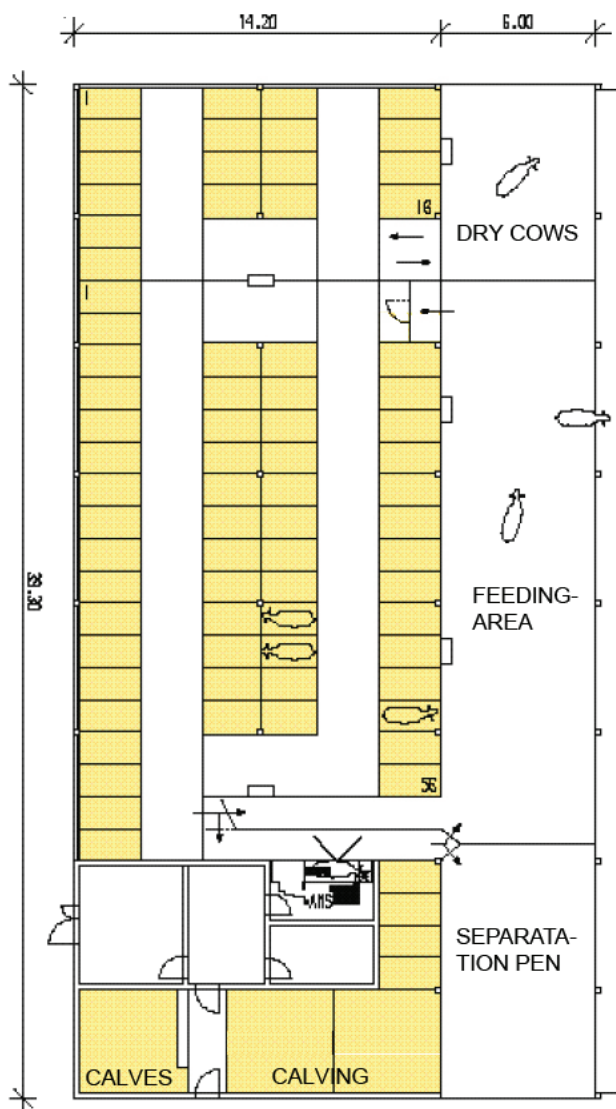

Figure 3.6.7.2.1: selectively guided cow traffic with single-stall system.

## 3.7 CLIMATE CONTROL

### 3.7.1 GENERAL

One important aspect of building design is the control of environmental parameters, which influence the animal production and welfare as described in Chapter 2.3. This can be achieved by employing a ventilation system that uses appropriate opening geometry and orientation. Other relevant aspects are: the thermal properties of the constructive materials, the building shape and orientation, the location etc.

Considering inside temperatures occurring in a cold climate, the housing systems can be categorized as either cold housing or warm housing.

In cold housing indoor temperatures are allowed to fluctuate closely to outdoor temperatures. Ventilation is sufficient to maintain indoor temperatures within 3°C to 6°C above the outdoor temperature. Usually this is accomplished through unregulated natural ventilation with appropriately sized ridge and eave openings along with adjustments in door and wall openings. The regular air exchange required during cold weather, to control moisture, makes insulation unnecessary. Condensation on the underside of the roof can be considered as a management tool or signal for the farmer that excess moisture build up is occurring and additional openings must be provided for a better air exchange.

Warm housing applies to insulated and closed buildings, with well controlled ventilation. These animal houses are designed to provide a relatively uniform environment throughout the winter and consequently they need careful management of ventilation by proper regulation of the openings. Tie stall houses, where indoor temperatures are to be maintained at least above freezing, remain the principal example of this type of housing for dairy animals. In these buildings condensation problems can arise when the insulating properties of the shield has a discontinuity (i.e. thermal bridges).

Some animal buildings do not fit into either the warm or cold category. In-between housing or modified environment housing is obtained when the indoor temperatures in winter are kept above freezing by some degree of insulation and by partially closing the openings during extreme weather. A typical case is a sidewall open building with insulated roof when the opening surface is restricted by means of closing panels or materials (i.e. straw bales).

In this way, a potentially cold barn may not be operated and managed as a cold barn, and problems of excess moisture build-up and a high relative humidity can arise unknown to the stockpersons because surface condensation is prevented from forming by insulation.

### 3.7.2 VENTILATION

Ventilation is a process by which outside air is brought into a building where it collects moisture, heat, dust and other contaminants. Therefore, ventilation is the main instrument for controlling the internal environment parameters: air temperature, air humidity, air quality. To this purpose a uniform distribution of air inside the building is an important requirement of proper ventilation. The air exchange can be realised by natural processes or by means of mechanical devices.

### 3.7.2.1 Natural ventilation

Natural ventilation is by far the most common system for the air exchange used in dairy buildings. It works in two ways: by thermal buoyancy (stack effect) and by wind action.

#### 3.7.2.1.1 Thermal buoyancy

Thermal buoyancy is due to different air densities generated by air temperature difference indoors to outdoors. Therefore, its action is relevant only in a cold climate and particularly in closed insulated buildings (warm housing).

In addition to the temperature gradients the air exchange depends on the openings geometry (size, shape and position). An important factor is the vertical distance between the lower and the upper openings. A typical case is that of buildings with ridge and eave openings where the air flow can be calculated (as for chimneys) using the following formula:

$$V = C_d \cdot \sqrt{\frac{2gH\Delta T}{T_i \cdot \left( \frac{1}{A_i^2} + \frac{1}{A_o^2} \right)}}$$

- where: V = Ventilation rate (m<sup>3</sup>/s)
  - C<sub>d</sub> = coefficient of discharge of the openings (0.5 - 0.6)
  - g = acceleration of gravity (m/s<sup>2</sup>)
  - H = height difference between the lowest and the highest openings (m)
  - ΔT = temperature difference inside-outside (K)
  - T<sub>i</sub> = absolute inside temperature (K)
  - A<sub>i</sub> = area of inlet openings (m<sup>2</sup>)
  - A<sub>o</sub> = area of the outlet openings.
- (As shown in Figure 3.7.2.1.1.1).

For the best efficiency: A<sub>i</sub> = 2A<sub>o</sub> up to = 3A<sub>o</sub>

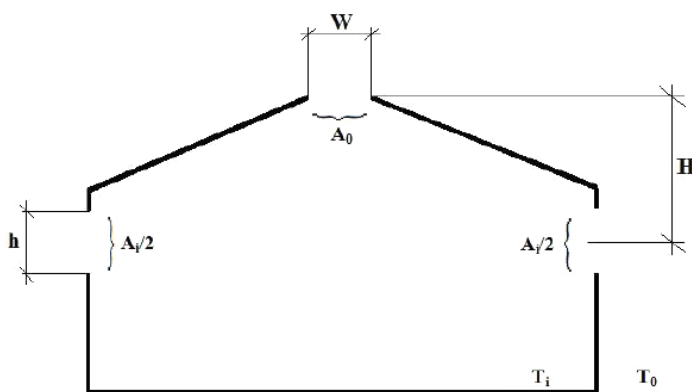

Figure 3.7.2.1.1.1: sketch building showing open ridge and side openings.

In the case of open front houses in which the three other sides are completely closed (e.g. mono-pitch calf housing), the incoming and outgoing air have to pass through the same opening. In this case the colder air (normally the outside air) flows through the under part and the warmer through the upper part of the opening. For rectangular openings the air flow by thermal buoyancy can be calculated by the equation:

$$V = \frac{A}{3} \sqrt{\frac{2g \cdot H \cdot \Delta T}{T_i \cdot (2k)}} \quad (\text{m}^3/\text{s})$$

- where: H = height of the opening (m) (difference between the outlet and inlet)
- k = coefficient of resistance of the opening
- A = area of the opening (m<sup>2</sup>)

From this equation the formula for the area of the opening can be derived:

$$A = 3 \cdot V \cdot \sqrt{\frac{T_i \cdot (2k)}{2g \cdot H \cdot \Delta T}} \quad (\text{m}^2)$$

This ventilation system is only suited for buildings that are not wider than 4 times the average height. During summer parts of the wall opposite to the open front have to be opened, in order to increase the ventilation rate by transverse air flow.

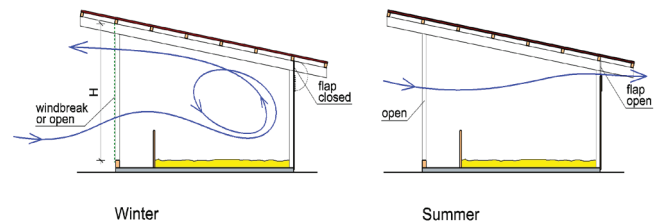

Figure 3.7.2.1.1.2: ventilation flow driven by stack effect during winter and summer in an open front young stock house.

#### 3.7.2.1.2 Wind action

The pressure exerted by the wind on the building surfaces determines an air flow going from the windward openings to the leeward. Therefore, the ventilation depends on the wind speed and the geometry and orientation of the vertical openings, with the contribution of the open ridge being negligible.

A formula for calculating the air exchange is:

$$V = E \cdot A \cdot V_w$$

- where: V = volume of ventilation (m<sup>3</sup>/s)
- A = windward (or leeward if equal) opening area (m<sup>2</sup>)
- V<sub>w</sub> = wind velocity (m/s)
- E = effectiveness of the opening (0.5-0.6 for perpendicular winds, 0.25-0.35 for diagonal wind; a value of 0.35 is normally recommended for agricultural buildings).

The wind action is generally the most important factor of natural ventilation. However, the control of the ventilation is difficult due to the variability of the wind speed and direction. Hence Automatically Controlled Natural Ventilation

(ACNV) systems have been developed; i.e. automated control systems using mechanical opening or closing of ventilation flaps or windows, which are activated by temperature sensors and possibly air speed sensors.

A simple solution to control the air velocity inside the building is offered by the use of windbreaks; i.e. perforated surfaces capable of reducing the wind speed to values steadier and more suitable for animals. Windbreaks are of different kinds e.g. timber planks (spaced boarding), perforated metal or plastic nets.

### 3.7.2.1.3 Combined effect of thermal buoyancy and wind

In special situations, e.g. absence of wind associated with cold days, thermal buoyancy is the prevailing source of air exchange. In most cases wind effect will dominate, particularly with large side openings. In intermediate situations (no one dominating), buoyant and wind induced ventilation rates cannot be simply added, because of interaction between the two effects.

Figure 3.7.2.1.3.1 shows the results of a theoretical calculation applied to a typical dairy house for different temperature gradients and wind speed values. It can be seen that the action of the thermal buoyancy becomes negligible with temperature gradients lower than 10°C and wind speed higher than 1 m/s and, in any case, when the wind speed is higher than 2 m/s (with vents/windows fully opened and without windbreaks).

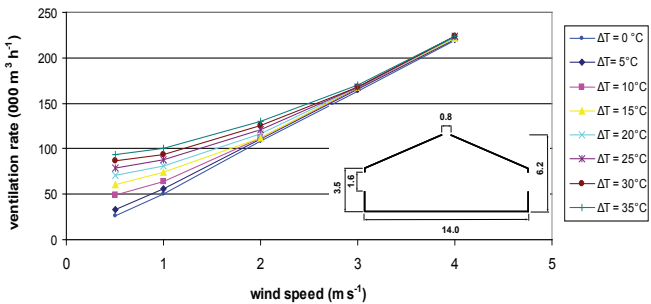

Figure 3.7.2.1.3.1: ventilation rates in a typical dairy house 30 m long with continuous non-protected openings for different temperature gradients (difference between inside and outside temperature) and different wind speeds (m/s). In the calculated model the wind direction is constant and perpendicular to the opening.

To correctly determine the combined effect of the two separate mechanisms requires a quite complex procedure.

### 3.7.2.1.4 Control of the air flow

Inlets should be designed and positioned to avoid cold air draughts around the animals. Therefore, adjustable hinged flaps at the eaves, or different types of wall cladding, such as spaced boarding, louvered plastic coated steel sheeting or polypropylene mesh can be used in cold houses. In areas where strong winds occur, windbreaks should be provided on the upwind openings. Therefore a reduction of the air speed is obtained depending on the porosity (ratio of void to the total opening area), structure and material used.

To calculate the air exchange, an experimental determination of the effectiveness (coefficient of reduction of the wind speed) of the material or cladding is required. The greater the coefficient of reduction, the larger the area of protected air inlet must be in order to obtain the same ventilation rate as with a free opening.

A simple solution to estimate how much larger the protected air inlet must be is to use a multiplying factor. This factor ( $M_f$ ) can be derived from the resistance coefficient ( $k$ ) through the formula:

$$M_f = \sqrt{k}$$

In case the resistance factor is not known, the multiplying factor can be estimated as the reverse of the porosity (e.g. for common wind breaking net the factor is 3 - 5 according to a porosity of respectively 30 or 20 %).

Another possibility of obtaining a reduced and more uniform air movement inside the building consists of adopting slotted or perforated roofs. However, this solution must be considered only as integrative, not alternative to the windows, suitable for very large buildings or buildings with insufficient opening area and where the air diffusion in the inner space would be problematic.

The flow and the distribution of the fresh air inside the building is more efficient when the buildings are narrow and with the main axis oriented perpendicular to the prevailing wind direction. In Figure 3.7.2.1.4.1 some typical schemes are shown. Buildings larger than 18 m span should have additional intermediate openings over the roof (e.g. cases b, d and g); however, case (a) is generally not a good solution due to the risk of condensation and bad distribution of the fresh air. Buildings with shed shaped openings (case e) and without wind deflectors are to be avoided, since opposite winds can prevent the exit of exhaust air. Buildings with internal walls (case f), or other obstacles (case h) obstructing the air flow, are not advisable. For large buildings, or in cases of non-uniform air distribution, additional roof openings (i.e. slots) or mechanical ventilation, are required. Buildings with a mono-pitch roof (c), though fully opened at one side, require an opening on the opposite wall if larger than 8-10 m (especially in a warm climate). In any case should not be larger than 12 m. Tunnel shaped buildings (i) should have adequate lateral openings; in any case they should be not too long to allow an efficient longitudinal air flow.

Bearing in mind that the ventilation by wind is the most relevant factor, an equally important feature is building orientation. However, since the wind direction and intensity are variable, it may be appropriate to have openings in the windward walls, especially in larger buildings.

When wind speed is low, passage or access doors kept open can give a substantial contribution to the air exchange and distribution. Internal air speed and distribution are also dependent on the shape of the inlet vents, since the airflow entering can be directed upwards or downwards by varying the vent flaps orientation. The ability to do this is important to avoid cold air draughts close to the animals.

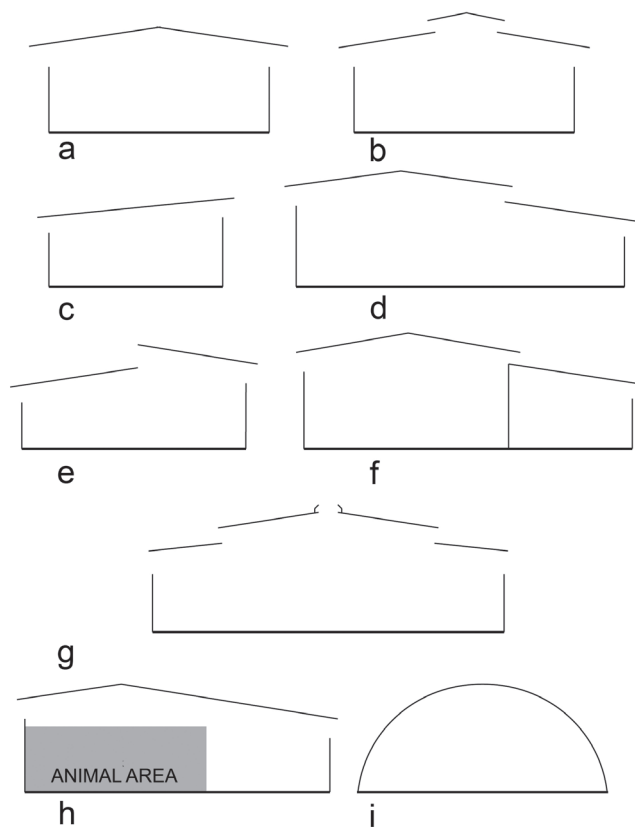

Figure 3.7.2.1.4.1: buildings with different types of natural ventilation.

### 3.7.2.2 Mechanical Ventilation

In dairy housing, mechanical ventilation is seldom adopted due to its cost and since dairy cows can tolerate wide temperature fluctuations. This system is most often associated with warm housing (where ventilation must have a high degree of control) and can be suitable where the volume of air to be exchanged is small (as in the case of warm barns in cold climate or small closed spaces) and if the energy price is low.

A solution introduced in the USA is the “tunnel ventilation” that is realised by installing large propeller fans, with potentially high flow rates, in one end wall of a barn, resulting in longitudinal air flow from an inlet located in the opposite end wall. Some investigations showed it is possible to reduce the differentials of temperature between indoor and outdoor during the heat of the day; furthermore, a cooling air stream can be produced at the animal level. However this solution is suitable only in specific housing conditions (buildings not too large or long and with right shape) and requires an accurate design.

An intermediate solution between natural and mechanical ventilation, as already mentioned, is automatically controlled natural ventilation (ACNV).

### 3.7.2.3 Cold climate winter minimum ventilation

A minimum rate of ventilation is required in animal housing even in a cold climate regardless of outside temperature. This minimum rate is necessary both with warm or cold housing. In addition, the minimum ventilation should be continuous in order to obtain appropriate dilution of in-

side air and to maintain the concentration of contaminants at minimal levels. The minimum rate depends on weather, design conditions, number and type of animals in the building, their age and size, and whether the building is intended to be cold or warm.

The amount of air flow required can be calculated using the formula:  $V = X\Delta x^{-1}$

where:  $V$  = volume of air required ( $m^3/h$ )

$X$  = amount of contaminants or noxious gases produced per hour inside the building ( $g/h$ )

$\Delta x$  = difference in the content of these elements ( $g/m^3$ ) between the internal and the external air.

Generally the vapour in the air is the gas that first reaches the critical level. As the air temperature lowers, the ventilation rate should be increased to avoid too high relative humidity. But for closed insulated buildings in a very cold climate, or when slurry is mixed under slatted floors, other noxious gases can exceed the recommended threshold.

To obtain an efficient stack effect the open ridge should be protected with baffles, which will help create a suction effect by the wind. Furthermore, to avoid draughts around the animals building side openings not protected by windbreaks should be located at least 2 m above the floor. When outside air temperature is very low and the resting area is just below the openings the risk that cold air will drop onto the animals should be prevented by positioning deflecting baffles above the stock.

With natural ventilation, the minimum ventilation is more difficult to control. However, when mechanical ventilation is used, the control system and capacity of the fan(s) should be matched to the ventilation rate that is calculated for the particular housing situation.

### 3.7.2.4 Hot climate summer ventilation

Summer ventilation rates should generally be as high as possible in order to eliminate the heat produced by the animals. It is desirable to keep the internal temperature as low as possible at the same time as increasing the air speed inside the building to assist removal of animal heat by convection and transpiration. This result should be obtained by maximising opening area in all four sides of the building (taking care to avoid draughts if the outside air temperature drops).

During the hottest hours of the day the temperature difference between the inside and outside is often too low (often negative due to internal evaporation) making thermal buoyancy totally ineffective. So the wind effect becomes the only source of air exchange, through the vertical openings exposed to the wind.

In very hot periods it is extremely important to utilise the maximum benefit from the fall in night-time temperature.

### 3.7.2.5 Minimum air volume

The air volume per animal inside a building (static air volume) can play an important role on air quality whilst the minimum ventilation rate fluctuates up or down. Reducing the ventilation rate and starting or increasing production of air contaminants increase the concentration of air contaminants. In large volume buildings the increase is slower compared to small volume buildings (Figure 3.7.2.5.1). Ad-

ditionally, the variation in gas concentration during the day is reduced. It means that concentration of gas, dust and micro-organisms and its variability during the day can be reduced by dilution (buffer effect). Furthermore, the inertial action of the air mass can help to maintain the climatic parameters in a steady state.

The gas concentration in non-steady state conditions can be calculated by:

$$c = \left[ \frac{X}{V} + c_a 10^{-6} - \frac{X - V(c_0 - c_a) 10^{-6}}{V} e^{-\frac{V \cdot 3600}{\text{vol}} t} \right] 10^6$$

where:  $c$  = Gas concentration after time  $t$   
 $t$  = time (h)  
 $X$  = amount of gas produced ( $\text{m}^3/\text{s}$ )  
 $V$  = ventilation rate ( $\text{m}^3/\text{s}$ )  
 $c_a$  = gas concentration in the outside air (ppm)  
 $c_0$  = gas concentration in the building at the beginning ( $t=0$ ) (ppm)  
 $\text{vol}$  = air volume of the building ( $\text{m}^3$ )

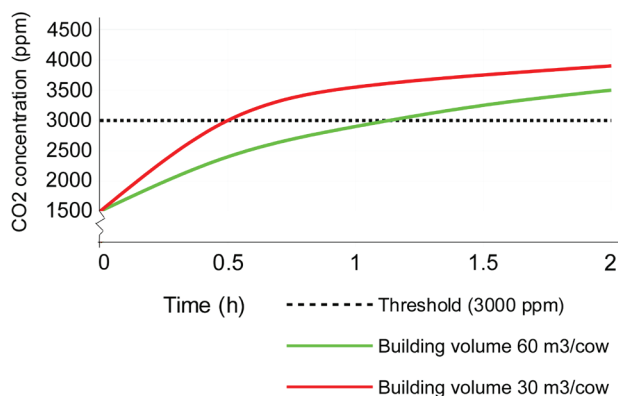

Figure 3.7.2.5.1: the smaller the building volume the faster the carbon dioxide ( $\text{CO}_2$ ) is increasing after reducing the ventilation rate from  $160 \text{ m}^3/\text{h}$  to  $50 \text{ m}^3/\text{h}$  per cow.

### 3.7.3 REDUCING HEAT STRESS

Heat stress is one of the biggest problems to be faced in warm climates, especially with the high yielding cows. The possibilities of minimizing its negative effect through the building and plant design and management can be divided into two categories: the “passive” and “active” tools.

#### 3.7.3.1 Passive tools

The passive tools are related to the design and management of the building structure. The most important goal is maximising the natural ventilation, not only in terms of air exchange, but also in terms of air speed close to the animals. This can be achieved by proper sizing, positioning and orientation of the openings. Orientation towards the prevailing summer winds, while avoiding obstructions that restrict or deflect the wind flow is preferable. A minimum distance of 20 m from trees or other buildings should be maintained, but this value has to be increased if the upwind structure is longer than 25 m or higher than 6 m (e.g. 30 m if longer than 120 m or higher than 9m). Generally, an elevated site, but not too exposed, is preferred for the location of the building.

Another goal is to minimise solar gain, both as direct radiation (bearing upon the animals) and indirect (affecting the internal environment through the openings and the transparent surfaces). Direct solar radiation can be avoided by providing sufficient and appropriate shaded space in addition to ensuring proper orientation of openings and any transparent building surfaces. Generally, rectangular shaped buildings should be positioned with the main axis running east-west to reduce solar radiation. In such a situation, one long wall is always shaded and the opposite receives inclined sun rays (so less effective) and can be partly shaded by the roof overhangs. The East and West walls (gable ends) receive the sun rays at right angles and have the smallest area and can be shaded by trees or other buildings. Plastic nets and mature trees can help provide shade in external yards.

The use of insulation in the most exposed surfaces is another way of reducing radiation onto the animals from building surfaces heated by the sun (in practice the roof). In addition, using reflecting materials or colours on sun exposed surfaces can be useful too, but these properties decrease with time from deterioration. Very high and sloped roofs can be an alternative to insulated ones for reducing the radiation flow onto the underlying animals.

It may also be important to prevent radiation being emitted from surfaces that surround the building (mainly the paved floors) that are exposed to the sun. This can be achieved by shading these areas or, simply, by avoiding paved floors wherever possible.

Ventilation is another important way for reducing heat stress as this can increase the heat loss from the animals’ body, both by convection and transpiration. Therefore, opening up a building as much as possible so that it acts as a sunshade can be very useful in hot weather. When openings cannot be created in summer, or obstructions to openings cannot be removed, consider adding supplementary cooling.

Overall, appropriate building orientation is a fundamental aspect of design. To this purpose both the sun and the wind exposure must be considered together in order to provide protection from solar gain and good ventilation. Often a compromise between the two will provide an optimal solution.

A positive effect can be obtained by adopting a lying surface with high thermal conductivity, i.e. the use of sand (or soil) as a litter instead of straw or synthetic mattresses can significantly improve the animals’ heat dissipation.

#### 3.7.3.2 Active tools

The active tools, considering mechanical ventilation, can be:

- a) increasing air speed through fans directed towards the animals
- b) air cooling through water evaporation (adiabatic cooling)
- c) animal cooling by the misting or sprinkling of water upon their body and blowing air with fans.

a) The air moved by fans around to the animals increases the heat loss from their body, both by convection and transpiration (see Chapter 2.3). This practice is effective from a temperature of  $23\text{-}24^\circ\text{C}$  upwards. The fans can be of two types: “low volume (small diameter) and high velocity” with horizontal axis, and “high volume and low velocity”, with vertical axis. The first type has to be oriented towards the animals. It produces a higher air speed (the effect decrea-

sing with the distance) and involves a smaller area. Ideally, they should be oriented in the same direction as the prevailing summer breezes. Normally, this is the most effective system if fans are positioned high enough to prevent any “screen” effect caused by animals crowding together. In the second type, fans are generally suspended just below the roof, and produce a lower air velocity and cover a bigger area as they are suspended at a greater distance from the floor. This system can be suitable for large and non-linear spaces (i.e. resting area, holding pens) provided that there are no obstacles at ground level to reduce the effect.

As mentioned in Chapter 2.3, this cooling technique is limited to the maximum rate of natural heat dissipation by transpiration from the animals’ skin. So the evaporation of additional water can be exploited to increase the cooling benefit.

b) The adiabatic evaporative cooling is realised by fogging water (with high pressure misting devices) in front of fans blowing air towards the animals. In this way the evaporation of the water brings a reduction in the air temperature. The potential to absorb water vapour is greatest when the relative humidity is the lowest. Therefore this technique is suitable for dairy housing only in dry climates. The benefit of air temperature reduction becomes marginal at ambient humidity beyond 45 %; in fact, on one hand the release of sensible heat is increased, but on the other hand the natural transpiration is reduced. The advantages of this system are that a substantial reduction of the temperature can be obtained in dry climates with a minimum use of water and that it is suitable in areas where sprinklers cannot be used for the risk of wetting the floor (i.e. littered surfaces). On the other hand, the efficiency can be reduced if the evaporation of water is not complete, since droplets can create an insulated layer to the hair coat. Furthermore under windy conditions the cooling effect can be dispersed outside the building by the wind.

c) Misting or sprinkling water onto the animals with low pressure nozzles and blowing air on their body by fans to increase the evaporation seems the most effective solution for reducing heat stress in dairy cows, especially in hot-humid climates. With this technique, not only the natural mechanisms of heat dissipation by the animals’ body are activated, but an important supplementary effect is obtained through the evaporation of the additional water sprayed upon the animals’ skin (it can reach up to 10 times the natural evaporation). However, the amount of water sprayed on the body surface is critical, as is the air velocity around the animals’ body. The use of misting (drops of small dimensions) has the advantage of saving water and reducing wetting of the floors. However, sprinkling (drops of bigger dimensions) is more effective because it produces greater evaporation and has a longer term effect.

The design of these systems (concerning the choice of the nozzles or sprinklers, their density and position, the type and position of fans) and their optimisation (duration and interval of watering) are complex to determine. They depend on: climate (air temperature, relative humidity and speed), animals (breed, production, hygiene and health) and housing (area involved, type of floor, capacity of the manure pits, etc.).

For the latter aspect, experience has shown that extending the treatment to areas outside the feeding alley should be considered. Another point is the waiting area in front of the milking parlour, where the animals are particularly stressed because of the lack of space and the length of time they

wait there. Another choice is the resting area, where great care must be paid to avoid getting the floor wet. Generally, the fans are activated when the air temperature reaches 23-25 °C and the sprinklers operate from 25-27 °C upwards.

## 3.8 FACILITIES FOR CALVES AND REPLACEMENT HEIFERS

### 3.8.1 INTRODUCTION

In dairy farming, calves are usually weaned (separated from their mother) close to birth. The calves will be housed either individually or in groups, depending on the management system chosen by the farmer. Calves can be housed in individual pens for a few days or for several weeks (2 to 8 weeks).

Regulations in the European Union (EEC Directive 91/629, EU Directive 97/2) lay down minimum requirements with respect to calf housing that must be met by the facilities and management systems and the equipment for veal calves.

The most important features of the directives are:

- individual housing is forbidden after the age of 8 weeks, except for veterinary reasons
- the width of individual cages must be equal to the height at the withers and the length equal to the length of the animal multiplied by 1.1
- partitions between cages must be open to permit sight and tactile contact between animals
- for group of animals, the free area per animal must be 1.5 m<sup>2</sup> with a live weight less than 150 kg, 1.7 m<sup>2</sup> with a live weight above 150 kg but less than 220 kg and 1.8 m<sup>2</sup> with a live weight above 220 kg
- the pen and the equipment must be built so that each animal can stretch, rest, stand up and groom without any difficulties
- litter must be provided for animals younger than 2 weeks;
- calves should not be restrained, except when they are in groups and then only for one hour during feeding
- if artificial ventilation is used, a fail-safe and alarm system must be installed
- keeping the animals permanently in the dark is forbidden. Natural or artificial lighting must be provided
- calves must be fed twice a day
- calves must receive adequate fibre and enough iron in their diet
- calves older than 2 weeks must have permanent access to fresh water.

These regulations are not enforced on farms with less than 6 calves and where the calves remain with their mothers to receive milk.

The type of housing for replacement heifers will depend on a range of factors including geographic location, availability of straw, size of the unit and on the housing system used for the dairy cows.

### 3.8.2 HOUSING SYSTEMS FOR CALVES

#### 3.8.2.1 Individual housing - hutches

Generally, unless using a prefabricated hutch, the size of the hutch should be as follows: length 2.0 m, width 1.5 m, height 1.5 m. In addition, hutches should have an outdoor run of more than 2 m<sup>2</sup> surrounded by either metal wire netting or fencing. There should also be a means of supporting a bucket for milk and other dry feed, and possibly



a hay rack. Litter should be provided such as straw, wood shavings, sawdust, shredded newspapers etc. and should be thick enough to provide a favourable lying environment. It must be dry and clean. Litter should be removed immediately after the calf has left the hutch.



Figure 3.8.2.1.1: individual housing-hutch.

Use of transparent or clear plastic type material in the construction of a hutch should be avoided in order to prevent the possibility of the 'green house effect' heating the hutch (i.e. potentially causing heat stress). Therefore, synthetic, opaque and reflective materials (light coloured materials) are recommended. They may also be built from wood panels and plywood.

The opening must not be oriented towards the direction of the prevailing wind, so preventing wind (draughts) and possibly rain entering the hutch. In many areas of Western Europe a south-east orientation is the most suitable.

Hutches should be placed on well drained ground, but due regard should be paid to local water legislation. This may mean placing on soil with a sand layer of 15 cm. After use, the sand should be removed to reduce the risks of contamination. If the hutches are placed on concrete, for ease of management and to help make cleaning and disinfecting easier, it is necessary to collect liquid run-off in an appropriate storage facility to prevent pollution and to comply with local regulations.

When the weather is hot, it is advisable to provide shade to the hutches (a physical screen, trees or other buildings) in order to avoid the negative effects of high temperatures. During the winter it could be useful to take measures to prevent the consequences of very low temperatures.

### 3.8.2.2 Individual housing - pens

A nursery pen is a part of a building that is exclusively reserved for newborn calves. However, it is recommended that calves are put into individual pens (at least) the first 2 or 3 weeks of age, where they can be monitored more easily. In organic farming, housing of calves in individual pens are restricted, e.g not allowed from one week of age.

Common pen size is in the range 0.90 - 1.00 m x 1.50 - 1.60 m, however the size should reflect the size and age of the calf. Pens, particularly if they have a perforated floor and liberal bedding, should be raised from the surface or ground, approximately 300 mm, as this will aid drainage and the removal of urine, and to allowed regularly cleaning of the floor. In cold barns, the thickness of the litter must be increased to prevent draughts around the calves.

Dismountable pens are available commercially, or can be made by the farmer himself i.e. with plywood panels for

the walls and hardwood for the (perforated) floor. The floor must be covered with a thick layer of dry and clean litter. Bucket supports, for feed and water, should be provided on the front.



Figure 3.8.2.2.1: individual calf pens.

### 3.8.2.3 Group housing

Group housing gives the opportunity for calves to socialise and to develop with animals of a similar age. It also gives the possibility for calves to develop their immunity against a wide range of micro-organisms.

### 3.8.2.4 Collective hutches

The collective hutches are designed typically to house a group of between 2 and 6 calves. The hutches are made of synthetic materials, or wood, and have, for example, space for 4 calves with an indoor area of 10 m<sup>2</sup> and an outdoor run (loafing/feeding) of 10 to 15 m<sup>2</sup>.

The inside of the hutch is provided with litter and some hay may be put in a rack. Roughage is distributed at a feeding barrier and anti-freeze drinking device is recommended.



Figure 3.8.2.4.1: collective hutch with outdoor run offering shade, which is important.

With collective hutches fixed on concrete, the outdoor run should have a non-slip surface.; and must be cleaned 1 to 2 times a week. Manure and soiled bedding have to be removed manually or the hutch has to be moved to another position by tractor.

### 3.8.2.5 Bedded sloped floor

Sloped floor systems are not recommended for calves younger than 6 months.

### 3.8.2.6 Straw yard with bedded lying area

These facilities are extremely suitable for young animals, if sufficient straw and proper ventilation is provided.

When the calves are housed for several months it is absolutely essential that any passages provide a firm footing so that their hooves remain strong and are kept in good condi-

tion. The surface should not be too rough but should prevent slipping.

With respect to labour costs the concrete floor may be replaced by a slatted floor provided that the spacing between slats is appropriate for the age of animals being housed and meets any the local regulations.

Table 3.8.2.6.1: characteristics of pens for group housing

Duration of the stay	Animal dimension		Fully bedded (m <sup>2</sup> /calf)	Lying area and passage on concrete or on slatted floor		Trough length per calf (m)
	H (m)	L (m)		Lying area (m <sup>2</sup> /calf)	Depth of the passage (m)	
Up to weaning < 100 kg	0.90	0.84	1.6	1.2	1.0	0.35
From weaning to 3 - 5 / 6 months (100 - 250 kg)	1.09	1.17	Not recommended to prevent excessive hoof growth	2.5-3.2	1.4-1.5	0.45

### 3.8.2.7 Cubicle house

Cubicles need a good management for calves younger than 6 months.

### 3.8.2.8 Fully slatted floor

Fully slatted floors are not recommended for dairy calves and replacement heifers.

### 3.8.2.9 Tie stalls

Tying stalls are forbidden by an EU directive and are not recommended in the countries where they are not forbidden.

## 3.8.3. FEEDING FACILITIES

Housed calves can be fed manually or by an automatic milk feeder.

In the case of manual feeding; calves should be housed in groups of 8 to 10 maximum and should be fed at least twice a day. Barriers, or other devices, can be fixed at the feed trough/pen front to separate the calves and help avoid competition. Calves should be held in this way for a maximum of one hour. Alternatively they can be fed using buckets.

In the case of automatic milk feeder, calves can be housed in groups of about 30, but it is recommended to have groups of about 10 calves. In general each automatic milk feeder has at least 2 milk dispensers (teat), and each milk dispenser can accommodate up to about 30 calves. The calves should be arranged in groups of equal age, so as to prevent hierarchic and health problems within the group. Calves receive milk replacer according to their needs or ad libitum. In automatic systems calves often wear a transponder collar or ear tag device, so that the machine identifies them and monitors and records the milk consumed etc. The automatic milk feeder should be installed at a dry, clean, frost free and easily accessible place.

### 3.8.4 VENTILATION

Natural ventilation and cold housing are recommended for raising calves. In some cases warm housing is the most sui-

table system to provide a good environment to the calves and to prevent diseases and mortality.

#### a) Bedded pack

For calves housed on a deep litter of straw (bedded pack) cold housing is the recommended system to provide a good environment to the calves. An open front with appropriate orientation, depending on prevailing wind and exposure to the sunrise is preferred. Movable curtains or screens, positioned on the opposite wall, are necessary to prevent draughts during the cold months and heat stress during the summer.

#### b) Slatted floor

Although fully slatted floors are not recommended, if calves are housed on a slatted floor, heating and mechanical ventilation may be necessary in a cold climate to provide a good environment for the calves. Insulation of the walls and the roof, in combination with the above, may help prevent low temperatures and high relative humidity of the air. During hot days, mechanical ventilation and thermal insulation can also help maintain an acceptable temperature in the house.

## 3.8.5 HOUSING SYSTEMS FOR REPLACEMENT HEIFERS

Generally all housing systems described in Chapter 3.1 and 3.2 can also be used for heifers. Often the housing system for replacement heifers is adapted to the system in which the cows will be housed later on.

Cubicle houses can be used for heifers where no or only small amounts of straw are available. Where straw is available for bedding, typical systems include facilities with bedded lying areas and solid unbedded or slatted feeding stands and access passageways. Facilities with sloped floors depend on the animals to move the fouled bedding down the slope for collection, may be suitable for heifer rearing, but not when bulling. Tethering in stalls is still used in some countries, as a management system for heifers, but this method of housing is not recommended.

### 3.8.5.1 Bedded house with concrete or slatted feeding stand

In this type of facility the animals come to feed on an area of solid concrete or an area covered with slats. In the case of solid concrete the area is cleaned by an electric, hydraulic or tractor powered scraper. Where a tractor is used, additional gates could be useful to keep the animals on the bedded area during cleaning. The design has the advantages that lower quantities of straw are required and that the geometry of the feeding stand does not change as the manure builds up over the housing period. Straw usage is in the order of 4 to 6 kg per animal per day. However, both liquid and solid manure is produced with the system. If slats are used in the feed stand it is important to minimize the quantity of straw entering the tanks to avoid problems with slurry agitation. A cross sectional view is shown in Figure 3.8.5.1.1. An outdoor exercise yard could be offered as an additional exercise area, so that a multiple area system is available. Minimum space requirements for heifers are given in Table 3.8.5.1.1.

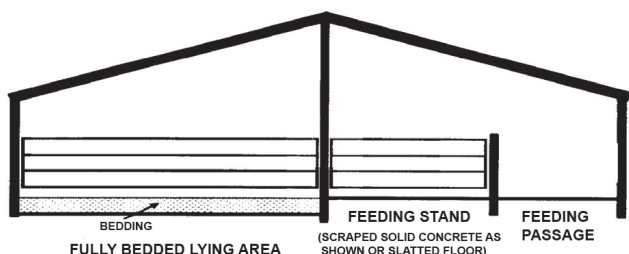

Figure 3.8.5.1.1: bedded house with concrete feeding stand.

Table 3.8.5.1.1: minimum space requirements for heifers in bedded house with concrete or slatted feeding stand, short or long stand (two area system)

Animal weight (kg)	L (m)	H (m)	W (m)	PW long (m)	PW short (m)	LA <sub>1</sub> long (m <sup>2</sup> )	LA <sub>2</sub> short (m <sup>2</sup> )	Total area (m <sup>2</sup> )	TL (m)
150-249	1.17	1.09	0.35	2.24	1.40	3.00	3.40	4.00	0.42
250-349	1.31	1.19	0.42	2.58	1.57	3.80	4.30	5.10	0.50
350-449	1.42	1.27	0.47	2.83	1.70	4.50	5.10	6.10	0.56
450-549	1.51	1.33	0.52	3.06	1.81	5.10	5.90	7.00	0.62
> 550	1.59	1.38	0.55	3.23	1.91	5.60	6.40	7.70	0.66

Long stand = is designed/dimensioned for two directions traffic behind eating animal on the passage-way

Short stand = the length of the (feeding) stand (passage width) is dimensioned/designed only for eating animal, i.e. traffic behind eating animal is calculated to be on the bedding area

PW long : passage width, long stand = 1.2 L + 2.4 W

PW short : passage width, short stand = 1.2 L

LA1 long : lying area, long stand = (H + W) (1.05 L + 0.48 H + W)

LA2 short : lying area, short stand = LA1 + (1.2 W x 2.4 W)

TL : trough length = 1.2 W

Total area : lying area + feeding stand area, dependent of passage width

### 3.8.5.2 Bedded house with sloped concrete floor

This housing system involves the frequent removal of manure, but daily straw requirements can be as low as 3 to 5 kg per animal per day. The floor is laid with a slope of 8 to 10%. The system operates on the principal that the movement of the animals will transfer the manure down the slope where it is removed by scraping. A cross section of a typical layout is shown in Figure 3.8.5.2.1. Minimum space requirements are given in Table 3.8.5.2.1.

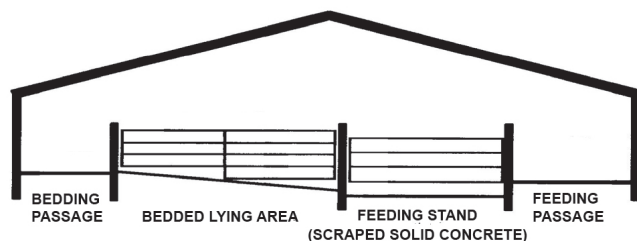

Figure 3.8.5.2.1: bedded house with sloped concrete floor.

Table 3.8.5.2.1: minimum space requirements for heifers in bedded house with sloped floor (based on CIGR standard dimensions for Holstein heifers)

Animal size				Lying area
Weight (kg)	L (m)	H (m)	W (m)	m <sup>2</sup> / animal
150-249	1.17	1.09	0.35	3.00
250-349	1.31	1.19	0.42	3.80
350-449	1.42	1.27	0.47	4.50
450-549	1.51	1.33	0.52	5.10
> 550	1.59	1.38	0.55	5.60

### 3.8.5.3 Cubicle house

A cubicle house provides an animal with an individual safe lying area. The system is widely used for dairy cows and the house type provides a clean lying area without the requirement for huge amounts of bedding material. Further aspects of design of the cubicle base are given in Chapter 3.1.

Major limitation with cubicles for heifers is the fact that as animal size is changing it is difficult to optimize the dimensions of the cubicle. As young cattle are more agile than older ones, cubicles must be narrower to prevent heifers from turning around in the cubicle and to getting stuck or making the cubicle too dirty. Table 3.8.5.3.1 shows the minimum space requirements based on Holstein Friesian heifers in cubicle houses.

Table 3.8.5.3.1: minimum space requirements for heifers in cubicle houses

Animal size			Length							
Weight (kg)	L (m)	H (m)	CW (m)	CRL (m)	HS (m)	HLS (m)	CL1 (m)	CL2 (m)	NRH (m)	NRD (m)
150-249	1.17	1.09	0.90	1.24	0.52	0.71	1.76	1.95	0.87-0.98	1.24-1.34
250-349	1.31	1.19	0.99	1.38	0.57	0.77	1.95	2.15	0.95-1.07	1.38-1.48
350-449	1.42	1.27	1.05	1.50	0.61	0.83	2.11	2.33	1.02-1.14	1.50-1.60
450-549	1.51	1.33	1.10	1.60	0.64	0.86	2.24	2.46	1.06-1.20	1.60-1.70
> 550	1.59	1.38	1.15	1.68	0.66	0.90	2.34	2.58	1.10-1.24	1.68-1.78

CW = Cubicle Width (free space) = 0.83 H

CRL = Cubicle Resting Length = 1.06 L

HS = Head Space = 0.48 H

HLS = Head and Lunge Space = 0.65 H

CL1 = Cubicle Length (space sharing) = CRL + HS

CL2 = Cubicle Length (non space sharing) = CRL + HLS

NRH = Neck Rail Height = 0.80 to 0.90 H

NRD = Neck Rail Distance = CRL + 0 to 0.10

### 3.8.5.4 Tie stalls

Heifers can also be housed in tie stalls. This may be especially useful where the main herd are housed in tie stalls. However tie stalls are not recommended for heifers. Detailed design of tie stalls is given in Chapter 3.2.

### 3.8.5.5 Outdoor yard and pasture

Animal welfare and health are positively influenced by providing an outdoor exercise yard and/or pasture. Special attention should be paid to the size and the flooring surface of the exercise yard. An outdoor yard for heifers up to 200 kg should have at least 2.2 m<sup>2</sup> per animal, for heifers up to 400 kg, 3.1 m<sup>2</sup> and up to 600 kg, 3.7 m<sup>2</sup>. However, two or three times this area is often provided.

## 3.9. SPACE FOR ANIMAL CIRCULATION

### 3.9.1. PASSAGEWAYS

Passages connect different function areas such as areas for resting, feeding and watering as well as different units in the overall dairy facility such as milking centre, dry cow area, maternity, young and growing cattle and areas for treating and handling. Many of these areas are open to continuous cow access as opposed to ones that may be only used when a worker is present and moving cows. The following recommendations are for hornless cattle. However, cattle with horns require about the same passage space, unless the horns are extreme in size.

Passageway design, construction and maintenance should consider the needs of the animal and the workers.

The following discussion relates to design and construction of passageways throughout the normal living and working areas of a dairy system. The information may be helpful when considering more specialized cow moving and confining areas that direct cows into or out of milking parlour stalls, scales, footbaths or veterinary/management holding devices. However, it is essential that additional requirements or experiences available from manufacturers and suppliers of the specialized equipment, animal health and management experts and users are considered.

Passageways and the dimensions and rules in this section should not be confused with more specialized animal movement or holding lanes, especially those that need to move or direct cows in a controlled single file path. These are usually part of special features or activities such as entrance and exit lanes, holding lanes, places where animals are diverted as part of their trip to or from the milking centre. Also management or palpation rails, crushes and portions of other areas designed and used for close work with the cow that requires more positive control (see Chapter 3.10).

Some general parameters to consider when designing and building passageways include:

- guide animals direction of travel as appropriate
- minimize cow injury from protruding objects, pinch points or other items/areas of potential injury
- avoid planned or unplanned openings in walls or fences that can entrap errant body parts of the cow (leg, tail, teat, head, tongue, etc.)
- obvious smooth transitions in lane width or directions with minimal sharp changes in directions
- adequate width for number and size of animals that are being moved at the same time
- gates or doors hinged to allow them to guide animals in the direction of desired movement and not interfere with flow
- special attention to areas where animals might become excited while being separated from herd mates or moved to a new place. Side heights, openness of sides and construction may need to be altered to discourage attempts to jump over, climb up or become entangled trying to escape
- addition of swinging gates that can aid the worker to direct animal in desired direction
- in areas where animals may be crowded along side walls consider rub rails mounted at a height to keep cows pin bones from being forced against the wall or caught against vertical posts. This will improve cow comfort and also minimizes damage to the wall or fence.

### 3.9.2 PASSAGEWAY FENCE AND WALL HEIGHT

The minimum height of any passage fence or wall within a typical housing system or herd movement passageway (PH) required is equal to height of the animal (H) (see Equation 1). This assumes that even if workers are present and directing cows from place to place it is done in a calm, non-aggressive manner and that the animals are not fearful. Areas where cows may be moved and held for veterinary treatment, separation from the herd and may be in a more excited state require specialized design with attention given

to height to discourage jumping, open spaces in sidewalls or fences that may tempt animals to try and go through them.

$$\text{Passage Height (PH)} = H \quad (1)$$

Race fence height in handling facilities should be 1.15H (see Chapter 3.10).

### 3.9.3 PASSAGEWAY WIDTH

All passages must be of minimum width that allows adequate access and reduces aggressive behaviour. The total area that allows the animal to behave normally must be considered when planning the passageways; the passageways often serve more than just circulation purpose, as well as other activities, such as feed intake, drinking and social and sexual behaviour. Size of the animal group and kind of animal are other parameters when determining the design of passageways.

It is thus, for example, that when the building welcomes groups with a great number of animals per group (200 and more), it is desirable to increase the width of different walkways in order to facilitate the circulation of animals. If the group of dairy cows consist of both first calvers, which considered as being part of the dominated animals, and multiparous cows (dominating animals), as well it is desirable to increase the width of the passageways to allow first calve heifers to easily use and reach the resting areas, feeding areas, drinking places, the milking robots, etc.. Groups including animals in late pregnancy, as well as certain strategies of feeding, also require an expansion of walkways width. When the circulation passageways are comparatively long, it is recommended to increase the width; and cross alleys should be planned in cubicle sections at least every 30 m.

The increase of the width of the alleys must be realized by the designer of the building that will have to call upon his personal experience and to his capacity to pull the conclusions of the realized observations in recent buildings. The farmer will have in addition to mark his agreement on the proposed solutions, while putting in relation advantages and cost supplements.

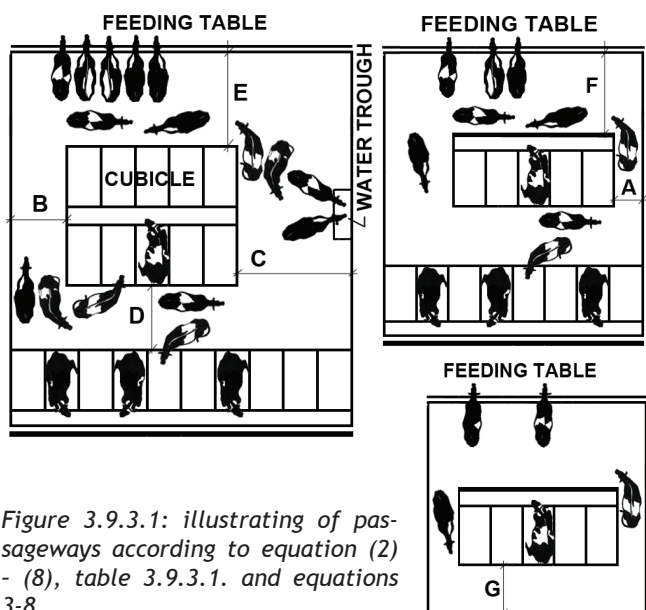

Figure 3.9.3.1: illustrating of passageways according to equation (2) - (8), table 3.9.3.1. and equations 3-8.

#### 3.9.3.1 Single file traffic passageway

Often, these passages connect rest area, milking centre, selection gates, as well as treatment, handling, calving and weighing facilities with each other and may require more care and knowledge in design and construction than in more free open movement areas. Adjustments of some dimensions based on experience of designer, recommendations of equipment suppliers, herd health professional and the owner should be considered. Sometimes cross passages in cubicle sections consist of one way passageway, but it is not recommended. Additionally, due regard should be paid to animals in late pregnancy. The minimum single file traffic passageway width is given in Equation 2.

$$\text{Single file traffic passageway width (WPA)} = 1.8W \quad (2)$$

#### 3.9.3.2 Two way traffic passageway

These passages allow animals meeting and passing each other, as well as passing animals that use different facilities in the passageways such as cubicles, feeders and drinkers. Therefore, one must plan the passageways to allow adequate space for animals and facilities to function properly and exhibit normal behaviour. Common passageways are along feeding table and cubicle rows, and cross passages. Design and installation of these passageways must account for fixed and moving space for animals normal eating and drinking behaviour; backing away from eating or drinking; backing out of and turning away from cubicle; or changing direction in the passageway. Different kinds of two way passages are shown in figure 3.9.3.1, and the minimum width of these passageways are given in Equations 3-8.

$$\text{Two way traffic passageway width (WPB)} = 3.6W \quad (3)$$

Passageway type B (Figure 3.9.3.1.) is aimed only to allow two animals to pass each other or walk side by side and holds no facilities, e.g. cubicle houses cross passages without any drinking vessels.

$$\text{Single sided watering two way traffic passageway width (WPC)} = 1.5L + 3.6W \quad (4)$$

Passageway type C is often a cross passageway with a water trough on one side in a cubicle compartment. The passageway width includes the water trough, which is assumed to be 0.4 m wide.

$$\text{Double sided cubicle two way traffic passageway width (WPD)} = L + 1.8W \quad (5)$$

$$\text{Feeding and cubicle two way traffic passageway width (WPE)} = 2L + 1.3W \quad (6)$$

$$\text{Single sided feeding two way traffic passageway width (WPF)} = L + 3.6W \quad (7)$$

WPE and WPF are essential for well functioning animal traffic and behaviour such as oestrus behaviour, social interactions, etc.. The passageway width must be designed varied mainly in view of animal group size (mainly dependent on number of cubicle rows), feeding strategy (i.e. restricted or ad libitum feeding) and access to outdoor exercising area. The passageway floor qualities can also be factors coming into play. For instance, if the passageway along a feeding table has soft flooring and the passageway along cubicle rows has hard flooring, likely, the animal will reside more frequent in the passageway along the feeding table than otherwise, because they prefer to walk and stand on soft floor.

Single sided cubicle two way traffic passageway width (WPG) =  $L + 1.3W$  (8)

Passageway type G is rare in dairy cattle cubicle houses, but will be found in special layouts, occasionally.

Table 3.9.3.1: minimum passageway width recommendations with regard to animal category and weight (body dimensions) in centimetres

Category of animal	Weight (kg)	H (m)	L (m)	W (m)	Width of passageways (cm)						
					A	B	C	D	E	F	G
Calf	100	0.90	0.84	0.27	50	95	225	135	205	180	120
Heifers	150-249	1.09	1.17	0.35	65	125	300	180	280	245	165
	250-349	1.19	1.31	0.42	75	150	350	205	315	280	185
	350-449	1.27	1.42	0.47	85	170	380	225	345	310	205
	450-549	1.33	1.51	0.52	95	185	415	245	370	340	220
	> 550	1.38	1.59	0.55	100	200	435	260	390	355	230
Dairy cow	550-649	1.40	1.69	0.55	100	200	450	270	410	365	240
	650-749	1.44	1.75	0.60	110	215	480	285	430	390	255
	750-850	1.48	1.80	0.64	115	230	500	295	445	410	265

A =  $1.8W$  Single file traffic passageway width  
 B =  $3.6W$  Two way traffic passageway width  
 C =  $1.5L + 3.6W$  Single sided watering two way cross passageway width; incl. water trough  
 D =  $L + 1.8W$  Double sided cubicle traffic passageway width  
 E =  $2L + 1.3W$  Feeding and cubicle traffic passageway width  
 F =  $L + 3.2W$  Single sided feeding two way traffic passageway width  
 G =  $L + 1.3W$  Single sided cubicle traffic passageway width  
 Note: animals in pregnancy need more space

### 3.9.3.3 Passageway corners and curves

At corners of passageways animals need sufficient space to avoid contact with boundary fences, walls or rails. Required additional space is due to the angle through which the cattle must turn; the width of the passageway approaching and leaving the turn, and other cows occupying space going in the same or opposite direction. Minimum extra space at 90° and 180° corners, respectively, is shown in Equation 9-10. Sharp turns on hard surfaces, expected speed of animal movement and crowding increase the risk of hoof injuries, slips and falls and reduce cow traffic flow. Use as gentle and smooth a turn as possible. Sharp inside or outside angles should be avoided. Sharp turns, especially complete reverses in direction, 180°, should be avoided. However, when moving animals up very steep slopes switch back type paths are often required to provide lower slopes. Also, when renovating existing buildings compromises are sometimes necessary because of limited space.

$$\text{Curve/entrance/exit B (90° corners)} = 2W \quad (9)$$

$$\text{Curve C (180° corners)} = 2.3W \quad (10)$$

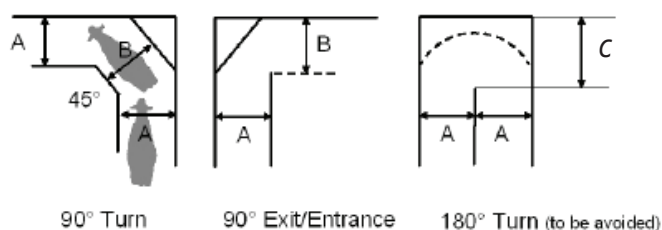

Figure 3.9.3.2: corner minimum width in one way passageway (A). Dotted lines show an option to improve cow traffic in a rectangular turn. Curves of 180° should be avoided to allow better animal flow and minimize injury.

Table 3.9.3.2: minimum space at corners in one way passageways in centimetres

Category of animal	Weight (kg)	H (m)	L (m)	W (m)	A (cm)	B (cm)	C (cm)
Calf	100	0.90	0.84	0.27	50	55	60
Heifers	150-249	1.09	1.17	0.35	65	70	80
	250-349	1.19	1.31	0.42	75	85	95
	350-449	1.27	1.42	0.47	85	95	110
	450-549	1.33	1.51	0.52	95	105	120
	> 550	1.38	1.59	0.55	100	110	125
Dairy cow	550-649	1.40	1.69	0.55	100	110	125
	650-749	1.44	1.75	0.60	110	120	140
	750-850	1.48	1.80	0.64	115	130	145

### 3.9.4 DOORS

Doors obstruct animal movement and circulation if narrower than the passageway width. The framework around the door, hinges or latches can also protrude such that animals bump off them or catch them. This can cause serious injury to the cow, impede animal flow and cause damage to the door. Doors that can be arranged so the sides of the passageway go through the door is desirable. Single file doors need to be at least the same width as single file passageways. In broad passages, it is advisable to accommodate more than one animal in the doorway. Therefore door width can be determined from Equation 11., where n is the number of animals to be accommodated in the doorway.

$$\text{Door width (DW)} = n(1.8W) \quad (11)$$

### 3.10 SPECIAL NEEDS FACILITIES AND ANIMAL HANDLING

#### 3.10.1 INTRODUCTION

A modern dairy cow unit should include facilities for both treating and handling the animals and taking care of animals with special needs. The facilities can be divided up into areas for animals that need special optimized housing conditions or particular treatment or handling. Special needs groups or categories of cows and heifers may be:

- early and late dry cows
- at risk lactating cows; such as lame cows, older cows, slow milking and convalescent cows
- sick cows
- transition cows and heifers; i.e. about 3 - 4 weeks pre-calving until about 2 - 3 weeks post-calving.

Transition cows and heifers may be divided into:

- close-up (or pre-fresh or pre-partum) cows and heifers; i.e. cows and heifers from 21 - 28 days pre-partum up to, but not including, calving
- heifers and cows giving birth
- fresh (or post-fresh or post-partum) cows and heifers, i.e. cows and heifers from calving to 14 - 21 days post-partum.

In smaller herds, it may be difficult to justify a special area, facilities and equipment for special needs cows. As herds become larger and management demands for improved cow care increase, such facilities are easier to justify and are more important; but it should be taken into consideration even in a smaller herd planning.

Above that, herd treatment, or treatment and checking of a specific animal, such as injections, deworming, claw trimming and insemination require facilities and equipment.

Handling and special needs facilities are of importance not only for animal care and welfare but also for biosecurity, risk management and worker safety. Special needs animals can be both a source of disease as well as some of the most susceptible animals to diseases. The ability to quarantine incoming stock and to isolate sick animals is crucial. A place near working areas to disinfect equipment should be provided. Worker safety considerations should include a means of escape from aggressive animals, minimizing entrapment hazards between worker and animals, as well as safe and comfortable flooring and good lighting.

#### 3.10.2 LOCATION

Special needs housing areas can be located in several separate houses, but it will increase labour requirement and require movement of animals. Location is mostly dependent on whether it will be used for lactating or non-lactating cows and heifers and hence should be near the target group. If special needs facilities are located away from the main milking centre, it may create a need for a 'hospital' pen near the milking parlour. However, where there is a risk of disease spread from such stock, the facilities should be isolated and hence positioned at a reasonable distance away from the main herd and housing etc.

It is usually best to locate special needs facilities in a building close to the milking centre so that cows have a short distance to travel to the parlour and back. Alternatively, the vacuum and milk lines can be extended into the facility to enable cows to be milked within the special needs unit and

hence prevent potential contamination of the milking parlour etc. Clearly, where access to the special needs unit is located on the normal exit route from the milking parlour, it will be easier to divert special needs cows as they are leaving the milking parlour. However, the sorting activity, using for instance a sorting gate, should be far enough away from the parlour exit so that the milking routine is not disrupted. Also, areas where intensive and potential distressing treatments are performed should be located so cows travelling to and from milking parlour, or the holding area, are not distracted.

Sorting cows on the exit route from the parlour can lead into several distinct areas. The first stop may be a short term holding pen where animals are held long enough for a quick examination and treatment before returning to their housing group or being directed to another area with facilities for longer term holding or treatment. Animals, which are not treated immediately and returned to their normal housing area, may be moved to an intermediate holding area whilst awaiting a visit by a veterinarian, hoof trimmer or breeder before being returned to their housing group. A third group may require separation from their usual milking group for several milkings due to the nature of the treatment or convalescence required. Animals in these areas should have access to water, feed and comfortable resting.

#### 3.10.3 HOLDING PENS

Selection gates from the return lane often divert cows needing attention after milking. Cows may be diverted into a stacking lane that runs parallel to the return lane or to a holding pen or sorting pen. As a minimum, a sorting pen should be sized to hold one side of the milking parlour, except where automatic or manual sorting takes place as cows exit the parlour. Animals in holding pens should have access to water and feed, and allow cows to lie down. Headlocks are important if the pen will be used for initial examination and simple treatment.

#### 3.10.4 HOUSING OF TRANSITION COWS

Transition heifers and cows in special needs facilities can be housed in either cubicles or loose housing (bedded yard). Irrespective of their normal housing system, it is essential that these animals have an optimized environment to live in, including proper ventilation, excellent floor surface and hygienic conditions, heat stress control, and extra space for resting and moving. Provide for smaller group sizes to reduce social stress, and danger and transmission of infection. It is recommended to design transition facilities to accommodate 25 to 35 % more animals than would be estimated using uniform calving, or correspondingly when estimated using calving seasons.

Cows need special attention during the first 2 to 3 weeks after calving. Providing a separate group and extra attention will typically result in improved performance throughout their lactation. Post-partum cows are about 5 - 6 % of the milking herd. Provide the best environment possible for these cows to relieve the stress of the calving process.

#### 3.10.5 CLOSE-UP AND CALVING PENS

Systems used for close-up and maternity animals vary and can include:

- cubicle sections, or bedded yards, for large numbers of pre-fresh animals with adjacent individual calving pens, where cows are put only during calving. This necessitates

round the clock observation to prevent cows from calving in the cubicle section.

- small bedded pens for 6 - 10 cows. The cows stay in this area through calving (“group calving pens”). The mother and calf are removed from this area as soon as possible following calving to individual pens or other appropriate facilities.
- small bedded pens for 6 - 10 cows and adjoining individual calving pens where cows are put only during calving.
- combination of a cubicle section, small bedded pens for 6 - 10 cows (“buffer pens”) as an intermediate position, and individual calving pens.

General recommendations:

Calving should not take place in cubicle sections because of hygiene, worker safety, risk of injury and loss of calves (e.g. because of scrapers) and disturbed colostrum intake etc. Ideally, the cow and calf should be in a pen on their own so that the calf can take on colostrum and not be disturbed by other stock. Additional pens will be required if cows and

their calves will be kept together for a few days before being separated. Individual calving pens can also facilitate good hygiene practices and be safer for the stockman. The purpose of “buffer pens” is to aid management and movements of cows to and from individual calving pens and reduce the risk of a cow giving birth in the cubicle section.

The number of individual calving pens should be calculated according to equation (1), and group calving or buffer pens according to equation (2).

**Individual calving pen area**

$$(ICPA) = 2L \times 2L, \text{ with the shortest side} = 1.85L \quad (1)$$

**Group calving pen area**

$$(GCPA) \text{ per cow} = 1.6(1.85L \times 1.2H) \quad (2)$$

The shortest side of group calving pen is dependent on the planned number of cows (See Table 3.10.5.1).

Table 3.10.5.1: minimum calving box dimensions for groups and single dairy cows

Weight (kg)	H (m)	L (m)	W (m)	Single box		Group box			
				Area (m <sup>2</sup> )	Side* (m)	Area (m <sup>2</sup> per cow)	Shortest side (m)		
							≤3 cows	4-10 cows	>10cows
550-649	1.40	1.69	0.55	11.4	3.1	8.4	3.1	5.3	7.5
650-749	1.44	1.75	0.60	12.3	3.2	8.7	3.2	5.5	7.8
750-850	1.48	1.80	0.64	13.0	3.3	9.0	3.3	5.7	8.0

\*shortest side

Individual box area = 2Lx2L  
Shortest side = 1.85L

Group box area per cow = 1.6 (1.85Lx1.2H)  
with the shortest side for:  
≤ 3 cows = 1.85L  
4 - 10 cows = 1.7 x 1.85L  
> 10 cows = 2.4x1.85L

Calving pens should be well equipped as shown in Figure 3.10.5.1 and 3.10.5.2.

To give newly delivered cow access to tepid water, in a bucket or corresponding facility, encourage drinking in order to remedy dehydration owing to delivery strain.

In order to have satisfactory hygiene at birth giving, all bedding material should be taken away and (individual) calving pens, and pen floor especially, should be cleaned properly. To avoid direct contact between recumbent cow (as well as newborn calf) and rough hard concrete floor, new bedding material in abundance should be brought. However, the cow when working with delivery moves new bedding material easily. Therefore, a soft pen floor surface as rubber flooring underneath the bedding is recommended.

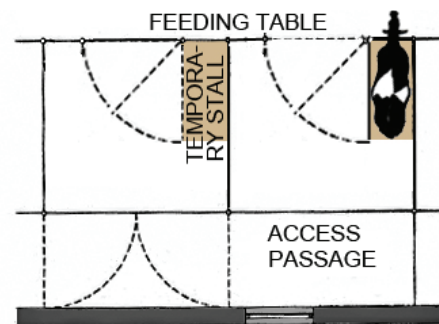

Figure 3.10.5.1: using revolving feeding gate as a wall in individual calving pens to create a temporary stall for delivery assistance or clinical examination and treatment.

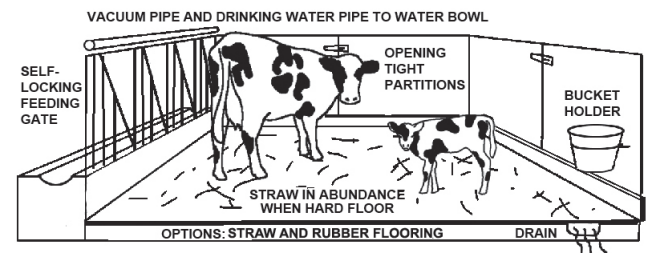

Figure 3.10.5.2: example of design and equipment of individual calving pens.



### 3.10.6 TREATMENT AND HANDLING FACILITIES

Treatment and handling facilities may consist of:

- palpation or management rail: front and rump rails for arranging cows in a long herringbone file before palpation or insemination
- single file race with raised walkways besides (catwalk) for giving injections among other things
- Parallel double races and sorting gates to sort animals into two groups
- crush with head gates and kiosk. Let at least about 1 m free space on both side as working area
- wide passages or rectangular catch pens with headlocks along one side can be used to temporarily lock up several cows for neck and head access
- claw trimming crate permanently installed or portable. A crush can be equipped for trimming operations.

Palpation rail is placed near and parallel to the return lane from the milking parlour. The design and dimensions are:

- lane width =  $0.7L$
- head space =  $0.7L$
- lane length per cow =  $1.3W$
- rail height
- rear rail =  $0.7H$
- lower front rail (at throat) =  $0.7H$
- top front rail (at neck) =  $1.1H$

and shown in Figure 3.10.6.1. and Table 3.10.6.1.

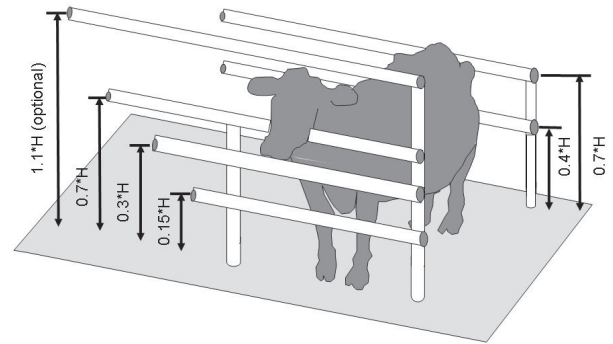
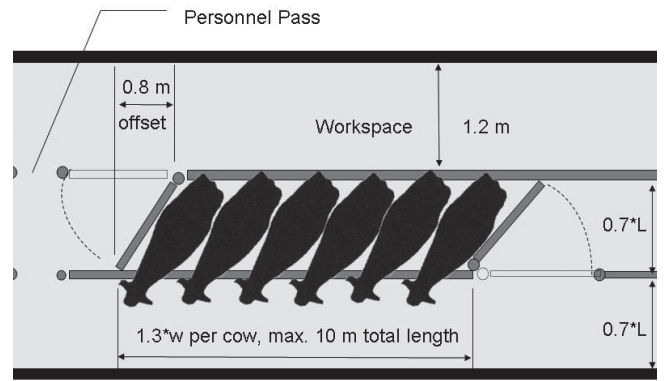

Figure 3.10.6.1: dimensions of palpation rail unit shown by plan and side view, respectively (after MWPS, 7<sup>th</sup> edition, 2013).

Table 3.10.6.1: dimensions of palpation rail

Animal	Weight (kg)	H (m)	L (m)	W (m)	Lane width (m)	Head space (m)	Length (m per cow)	Rail height (m)		
								Rear	Front lower	Front top
Dairy cow	550-649	1.40	1.69	0.55	1.20	1.20	0.70	1.00	1.00	1.55
	650-749	1.44	1.75	0.60	1.25	1.25	0.80	1.00	1.00	1.60
	750-850	1.48	1.80	0.64	1.30	1.30	0.85	1.05	1.05	1.65

A crush is used to secure and immobilise animals whilst they are being treated. The basic features are shown in Figures 3.10.6.2 and 3.10.6.3. Among the more important and desirable features are:

- a race without any corners leading to the crush, preferably, a curved race just before (behind) the kiosk and crush
- unobstructed personnel passes in the race for emergency use
- the crush should be “walk-through”, preferably with a self-locking head-gate
- in the crush the cow should be accessible from each side of the crush and from behind (kiosk)
- a shelf or a table near the crush for veterinarian’s equipment and materials.
- availability of hot and cold water.
- adequate area lighting for cow and worker movement and excellent task lighting where close observation and animal treatment occurs.
- availability of electricity for instruments and tools.

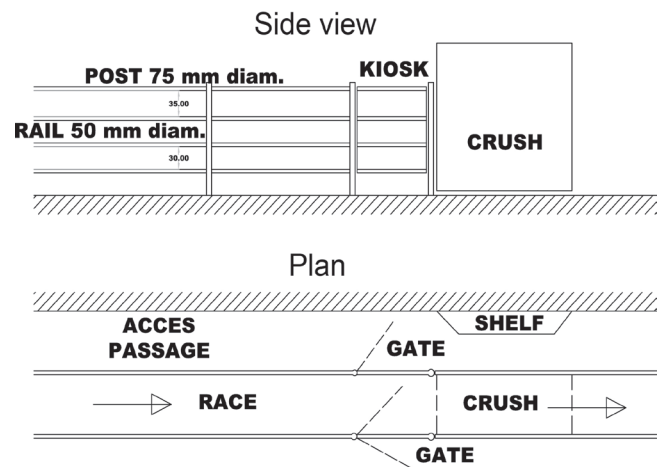

Figure 3.10.6.2: example of a treatment unit layout.

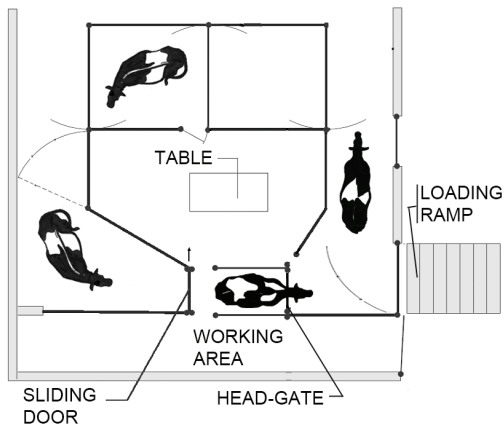

Figure 3.10.6.3: example of a compact treatment unit, which can be placed in a corner or an attached annexe, which is especially useful for smaller herds. (After Bickert et al, 2000).

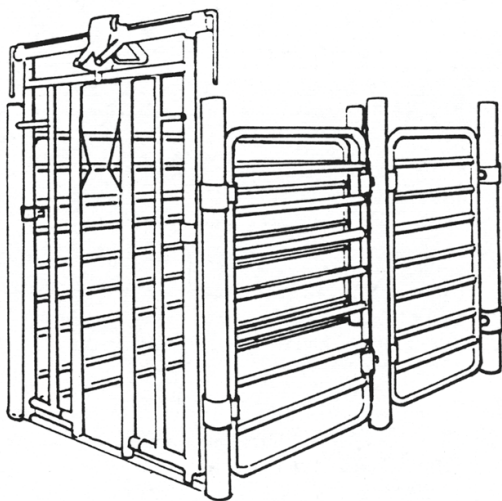

Figure 3.10.6.4: crush for dairy cows.

### 3.10.7 FACILITIES FOR OTHER SPECIAL DAIRY COWS

Facilities for other groups of special cows can be considered, especially in larger herds. It may be:

- Sick cow group. An area to treat and handle “downer” cows and other serious health problems is also needed. A pen for one cow should be sized as an individual calving pen, and with gate partitions, water bowl and feed trough. The pen should include a lockup and gate arrangement that allows one worker to catch easily a cow for close examination (see Figures 3.10.5.1). It is convenient to have easy access to these from outside the building for humans and safe delivery or removal of cows that are not mobile
- Special attention group. Many times, it will enhance the performance of the dairy if there is a group of cows that are kept separate from the mainstream cows because of some other special needs. This would include lame, injured, and slow or hard milking cows. They are typically housed in cubicles but may be on a bedded area
- Treated cow group. Any lactating cow that has non-saleable milk should be kept in a separate group to lower the risk of getting this milk into the bulk tank

- Market cow and dry off group. Many dairies also have an area that can be used for holding market cows. This area may also be used to hold dry off cows for a day or two whilst they get a reduced ration to help lower milk production before milking is stopped. This pen should provide for water, feed, resting and access to a loading chute
- Isolation group. Animals suspected of having a contagious disease should be completely separated from the rest of the cows to minimize the likelihood of spread of the disease. In many cases, the best way to handle this may be to move the cow to an unused barn away from the milking animals. For biosecurity reasons, it is necessary to prevent incoming infections to the herd. It is of vital importance to have facilities that make it easy for service personnel and visitors to have a wash and to change clothes or dress in protective clothing. They should use entrance doors leading directly to places at which service will be done resulting in a minimum of contact with the herd
- Foster cow group. Organic/ecological, but also conventional, dairy farms sometimes use foster cows to which the calves have access to suckle for up to weaning at 8 to 10 weeks of age. There are different selection criteria for foster mothers as well as management and housing systems for the cow and calves. The foster cow and calves can be kept single or grouped in cubicles or bedded pens. Figure 3.10.7.1 shows an example layout for grouped cows kept in cubicles. The foster cow section is often located near or in the calving section

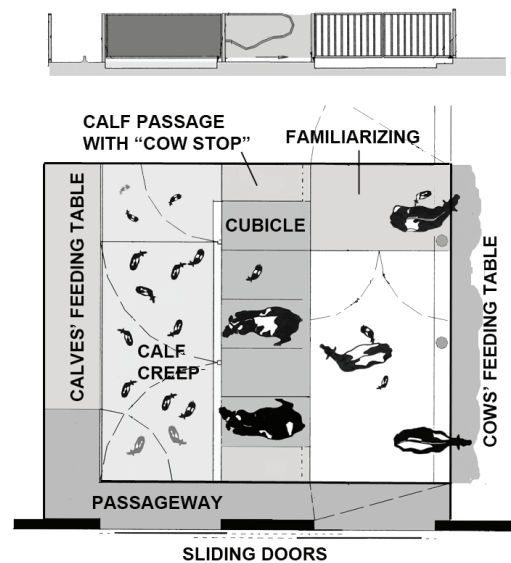

Figure 3.10.7.1: cubicle systems for five foster cows and their calves. The calves often prefer to lie down in front of the cows, which is the reason for the layout (after Norrbom, 2001).

## 3.11 HUMAN/WORKERS SAFETY AND HEALTH

### 3.11.1 INTRODUCTION

Stockmen working in animal housing and associated handling facilities are exposed to a number of potential risks and health hazards. Many stockmen work alone, handling big, sometimes dangerous animals as well as large groups of animals. Several work tasks involve daily lifting, carrying of heavy loads and awkward working postures, which may cause overload injuries on the worker’s musculoskeletal system. Other potential risk factors contributing to accidents as well as to physical health problems and physiological stress for the worker is the fact that they operate

in an environment where they are exposed to airborne particles, gases and noise. The work environment is partly the same environment, which is provided for the animals, and it should be noted that there is a strong relationship between the animal welfare issues and the handling of the work environment problems in cattle houses.

Some risk factors are common to a wide range of farming activities, i.e. use of machinery (tractors and so on), ladders and suspended platforms, transit areas and electric or heating plants, supply storage, chemicals manipulation, heavy loads lifting or moving. Some are specific to the animal breeding activity. Only these ones will be treated in this chapter and just for the aspects regarding the housing design and management (e.g. not the workers behaviour or equipment use).

### 3.11.2 ANIMAL HANDLING

Stockmen may work carefully with animals most of the time. However, accidents or injuries might occur because of preoccupation, impatience, haste or anger. During these moments, especially, a stockman needs to understand and anticipate animal behaviour in order to avoid dangerous situations and minimise the risk of accidents. Therefore, handling facilities should be designed appropriately and related to animal behaviour.

Regarding animal handling, a major part of their reactions can be explained by the characteristics of their vision. Cattle have a broad, nearly panoramic field of vision. This implies that, except for small blind spots at the nose and the rear, cattle are able to see all the way around them. Therefore, cattle should be approached from the side or the front in order to prevent startling reactions. Cattle also have a poor depth perception, probably poor acuity over 3 - 4 m distance and dichromatic seeing (green and blue). However, they have good seeing in darkness vs. human. Rapid changes in light intensity or at shadows may cause an animal to balk.

Another aspect of cattle behaviour to be taken into account is the fact that they have a so called 'Flight Zone' (Figure 3.11.2.1). Deep penetration into the 'Flight Zone' can cause panic and escape attempts. Handlers should be aware of this and where necessary remove themselves from the 'Flight Zone', particularly if the animal becomes aggressive. To move an animal forward: the handler should stand in the shaded area position 'B', behind the 'Point of Balance', at the shoulder. The person should keep out of the 'Blind Spot' at the rear of the animal. To stop movement: the handler should back off to position 'A'. To make an animal back up: the person should stand in front of the 'Point of Balance'. To make an animal turn left or right: the animal should be approached head on. Several factors can reduce an animal's 'Flight Zone' and therefore improve handling and human and animal safety, such as frequent contact with people, a history of gentle handling and a calm environment.

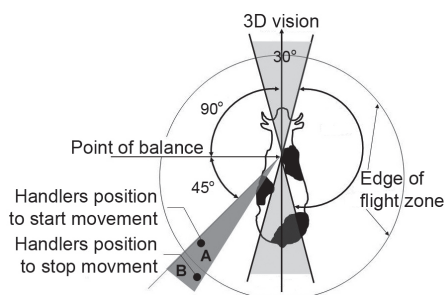

Figure 3.11.2.1: the 'Flight Zone' of cattle (Grandin, 1999a).

When a cow is, for example, frightened or is suffering pain, she might demonstrate kicking behaviour. Cows generally kick forward or out to the side and this should be considered when designing handling facilities and when in the milking parlour.

Special attention should be taken to cows with newborn calves and dairy bulls. A cow with a newborn calf can be more defensive and difficult to handle. Dairy bulls, by their nature, are more aggressive than cows and should never be considered as safe. Some dairy bulls seem calm and gentle but can react unexpectedly, resulting in injuries or even death of their handlers.

### 3.11.3 MOVEMENT OF CATTLE

When there is a need to move or handle cattle and specific (loading) ramps or chutes are used, they should be shaped and sized so as to facilitate the flow of animals (see Chapter 3.10). They should ideally have solid side walls to prevent animals from seeing outside distractions and also reduce and prevent escape attempts. The animals will be calmer and less stressed, which may lead to a reduced need for human intervention and therefore accidents. Cattle tend to move more freely from a dark to a more bright area. A spotlight directed on a ramp will often help to keep the animals moving, provided the light does not hit them directly in the eyes. Furthermore, illumination should be uniform and diffuse. Distractions should be prevented, such as a chain hanging down in an entrance. Sparkling reflection in a puddle should be avoided, as well as a moving reflection on a sheet of metal or bars of shadow across an otherwise sunlit alleyway. Dark colours can create shadow effects. Bright colours such as white and light yellow have been proven satisfactory.

Cattle are sensitive to changes in type and texture of floors and fences. Changes in type of flooring can cause balking. The same type of, if possible, non-slip flooring should be used throughout a facility. Drains should be located outside main drive alleys, chutes and crowd pens.

### 3.11.4 MILKING

The problems associated with milking relate mainly to poor provision of spaces and facilities in terms of ergonomics. Of particular importance is the shape of the parlour pit that must have:

- A depth of between 0.75 - 1.00 m commensurate with the height of the operator, (if necessary 'duck boards' or mats can be used to effectively raise the floor level, or a new floor could be installed). (See table 3.11.4.1.)

Table 3.11.4.1: recommended milking parlour depth depending on the type of milking equipment

Height of the operator (m)	Herring bone parlour or tandem depth (m)	Side by side milking parlour depth (m)
< 1.55	0.75	0.85
1.56 to 1.65	0.80	0.90
1.66 to 1.75	0.85	0.95
1.76 to 1.85	0.90	1.05
1.86 to 1.95	0.95	1.15
> 1.95	1.00	1.25

- An extended cow standing or a recess at the base of the pit wall that allows the milker's feet be placed below the edge of the cow standing so that the milker can stand closer to the cows and avoid stooping or bending their back too much.

The edge of the pit should be protected with a kerb, or rail, to prevent animals falling in, but, if possible, should be soft or flexible to avoid crushing of hands by cows altering their position. In addition, injuries might occur also because of kicking cows during milking. The use of anti-kicking devices (e.g. a leg restraint) might be used especially when cleaning or examining the udder and teats.

The access stair to the pit must have non-slip steps, be clean and free of other materials; if the stair is not placed between walls it should be equipped with a handrail.

The floor area must be non-slip, drained (slope 2%) and kept clean. Any obstacles should be removed and drain holes should be covered in a proper way. The walls should be painted with light colours.

Collecting yards should be provided with personnel refuges or 'squeeze gap' escape routes for personnel, should the need arise.

Injuries of muscles, tendons, nerves and joints can be caused by the milking equipment, such as milking clusters, and difficult restricted working positions (posture) during milking.

### 3.11.5 INSPECTION AND TREATMENT OF STOCK

Special facilities should be provided for veterinary and other such treatments, e.g. insemination, dehorning, hoof trimming and medication. Feed mangers may incorporate locking barriers that can be used to secure cows singly or in groups. However, in large herds separate handling and holding facilities will generally be required for veterinary and other treatments. The basic requirements of a system are:

- collection alley to move cattle from their housing, pasture or feedlot to the holding pen
- sorting pens. Opening off the collection alley or holding pens, or after the working area
- holding pens to hold either the whole herd or groups of 30 - 50 cattle
- crowding pen to move small groups of 8 - 10 cattle into the working area
- single file race, at least 6 m long to hold 3 - 4 cattle at once
- loading chute
- crush, preferably a "walk-through" type and with a self-locking head-gate
- options such as scales, calf crush or table, belly clipping crush, crush equipped for claw-trimming, access kiosk for artificial insemination and gynaecological examinations, shelf near the crush for veterinarian's equipment and materials, the availability of electricity as well as hot and cold water near the crush.

For more information on the design of cattle handling facilities, the CIGR report "Design recommendations of beef cattle housing" (2002) should be consulted.

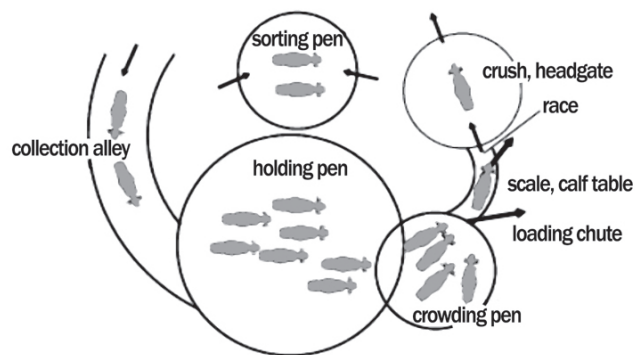

Figure 3.11.5.1: principal components of a cattle handling system (after Borg, 1994).

### 3.11.6 HOUSING ENVIRONMENT

#### 3.11.6.1 Air quality

It has been known for decades that farm workers suffer health risks due to inhalation of gases and airborne particles (dust). The particles may be liquid droplets or solid. The respiratory problems connected to gases range from mild irritations of the respiratory track to lethal effects. For the most frequent components in the air environment in live-stock buildings there are statutory threshold limit values, which differ from country to country. It should be noted that the threshold limits for humans should be slightly lower than those recommended for animal welfare (see Section 2.3.7).

Table 3.11.6.1.1: limits for concentration of the toxic gases (ppm)

Exposure	NH <sub>3</sub>	CO <sub>2</sub>	H <sub>2</sub> S
Prolonged	10	2500	2.5
Short	20	5000	10

Table 3.11.6.1.2: current safe maximum exposure limits recommended in Australia (Cargill et al., 2002)

Pollutant	Maximum safe concentration
Ammonia	10 ppm
Inhalable particles	2.4 mg/m <sup>3</sup>
Respirable particles	0.23 mg/m <sup>3</sup>
Respirable endotoxins	50 EU/m <sup>3</sup>
Total airborne bacteria	1.0 x 10 <sup>5</sup> cfu/m <sup>3</sup>

The main way to reduce risk is through proper ventilation, which should be substantially increased during agitation, mixing or pumping of slurry under slatted floors, in addition it is advisable to reduce the likelihood of gas production through frequent removal of manure from the building. It must be emphasised that it is dangerous to enter any manure tank without either using a self-contained air supply or taking appropriate precautions i.e. testing the air quality, providing constant and adequate ventilation of fresh air as well as using a harness and lifeline on the person entering the tank.

Dust in animal houses is generated inside the buildings and arises primarily from the animals bedding and feed materi-

als. The airborne particles are often carriers of biologically active material like endotoxins, pathogens and allergens that can be utterly disease provoking. Again, proper ventilation is an important factor for risk reduction. But, the most effective way to obtain a low dust concentration level is to prevent formation by using hygienically impeccable forage and bedding materials. The use of masks is sometimes necessary (e.g. handling of forage and bedding materials).

Biological agents (bacteria, viruses, fungi etc.) represent a potential risk when involving contact with animals and their biological materials (secretions, blood, urine, abortion products, manure etc.). Therefore, in addition to the use of appropriate protective equipment it is necessary to provide appropriate veterinarian facilities and consider the environmental hygiene of farms and stables (i.e. biosecurity).

### 3.11.6.2 Flooring

The floor must be:

- Not slippery; particularly when wet and sloped,
- Free from holes, hollows or protrusions,
- Draining into an appropriate drainage system (with appropriate channels and gutters properly arranged),
- Properly sloped for drainage purposes, 1 - 2 % (but not too steep so as to increase the slip risk),
- Holes, obstacles or steps must be adequately covered.

### 3.11.6.3 Lighting

In general, workplaces must have sufficient natural light. In addition they must be equipped with devices that allow for artificial lighting of adequate intensity and arranged as to avoid shadows and glare. The lighting systems must be kept in a good state of cleanliness and efficiency.

Table 3.11.6.3.1: light level recommendations

Areas	Minimum lighting (lux)	Recommended lighting (lux)
Transit and simple activities	100	150
Intensive work	150	300
Precision works (i.e. milking)	300	500
Interventions of particular difficulty (e.g. medical treatment)	500	1000

In places where there are risks of damage to the lighting system or power failure an emergency lighting of adequate intensity must be provided. Flourescent lamps have a lower risk of fire than incandescent ones.

### 3.11.6.4 Noise

Noise can be defined as unwanted sound or rapid, annoying pressure vibration in the surrounding air. Ventilation fans, grinders, vacuum pumps and mechanical feeding and manure systems generate noise. High sound levels are a real stress factor. Exposure to noise will be able to cause temporary deafness and permanent hearing loss after a variable period if the level is over 85 dB(A). (The unit, dB(A), is exponential and the human sense of hearing will perceive the

sound level as halving if a reduction of 10 dB(A) occurs). It is fairly easy to reduce the sound level of ventilation fans and other mechanical noise generators. Maximum noise level recommendations and regulations differ from country to country, but it can be recommended not to exceed 65 dB(A) continuously and 80 dB(A) for shorter exposure periods. Furthermore, it is important to reduce noise when handling cattle in order to improve animal movement and to make cattle handling safer. Equipment operated with hydraulics should be engineered for quietness. It is also recommended to install fixed engines in a cabin or in a separate space (e.g. pumps, milking pulsator).

## 3.11.7 ANCILLARY ACTIVITIES

Spaces properly sized and shaped must be provided for different housing activities.

### 3.11.7.1 Traffic routes, danger areas and passageways

The internal transit areas must be located and sized so that pedestrians and vehicles can use them safely, without risk to workers nearby. The size should be determined according to the number of users and the need for manoeuvring space of the mechanical equipment and a safe distance for pedestrians should be provided. Roof overhangs and aerial cables should be well marked and positioned at least 1 m, or more, above the highest vehicle.

Danger areas must be indicated and equipped with devices to prevent access by unauthorized persons; furthermore, appropriate measures to protect workers authorized to enter must also be taken.

### 3.11.7.2 Doors and gates

Doors and gates capable of being opened from either side (i.e. swinging doors) should be transparent or have transparent panels, with indicative signs at eye level on both sides. If the transparent surfaces of the doors and gates are not made from resistant materials, they must be protected against breakage and cleaned regularly.

Sliding or folding doors should have a security system that prevents them from being derailed or falling.

Mechanically operated doors and gates should be fitted with an emergency stop and be possible to open manually in case of power failure.

'Man-gates' should be present all around the cattle living areas. 'Man-gates' are generally small passages between two posts, approximately 30 to 50 cm apart, in the fence or a feeding barrier. A person can easily go from one area to another (without necessarily using a gate or a door, or having to climb over a feeding barrier or fence) but can also easily escape from unexpected, potentially dangerous situation.

### 3.11.7.3 Walls, windows and skylights

Walls should preferably have light colours. Windows, skylights and fans should be safe and easy to access or be closed or adjusted by workers. Avoid the use of control devices requiring staff to enter areas where loose animals may be present.

### 3.11.7.4 Emergency routes and exits

Routes and exits must not be obstructed by objects so that

they can be used at any time without hindrance. Minimum height is 2.2 m.

Where exits are equipped with doors, they must have an opening to the sense of the exit and, if closed, should be easy to open, particularly in an emergency.

Routes and exits must be marked by special signs and must be equipped with emergency lighting of adequate intensity, which is operational in the event of electrical failure.

### 3.11.7.5 Services

Rest rooms, changing rooms, showers and toilets must be provided close to the place of work. Toilets should be furnished with washbasins with hot water and provided with soap and a means of drying.

First aid kits, fire extinguishers and protection equipment etc. should also be provided.

### 3.11.7.6 Manure handling

When handling manure, especially when dealing with slurry pits; staff and animals may be exposed to several dangers. The most important ones are routinely generated gases in confined spaces, such as tanks, silos, and pits. Storing, pumping, mixing and spreading slurries can release large amounts of these gases. The gases of major concern are:

- Hydrogen sulphide: is a toxic gas which smells like rotten eggs at low concentrations. At high concentrations it decreases the human sense of smell. The gas can cause dizziness, unconsciousness and at high concentrations (>200 ppm) death. Hydrogen sulphide is especially released when pumping or agitating slurry
- Carbon dioxide: is a heavy odourless gas that is released when pumping or agitating slurry. Only extremely high concentrations (70,000 ppm or 7% and over) could have severe health effects. Mostly, incidents and accidents involving carbon dioxide are connected with asphyxiation due to oxygen deficiency rather than the direct effect of carbon dioxide itself
- Ammonia: is lighter than air. It can irritate eyes and the respiratory tract at low concentrations (5 ppm)
- Methane: is an odourless light and flammable gas. Methane is generated when manure is stored under anaerobic conditions. Its major danger is related with explosion in improperly ventilated spaces.

Because of the exposure to these dangerous gases and potential asphyxiation or even drowning due to unconsciousness and falling into slurry pits, the following rules should be employed when handling manure:

- Slurry channels and pits must be protected from fall hazards with barriers or covers resistant to the expected loads
- The underground manure tanks must be protected by a perimeter fence at least 1.80 m high with lockable gates together with appropriate warning signs (i.e. "Danger - manure storage"). The sampling points must be protected by anti-fall barriers. Children should not be present during manure handling, but if they are they should be properly supervised
- When manure is stored under slatted floors and will be mixed, staff should not stay in the building and stock should also be removed from the building, or if this is not possible all air outlets (doors, windows etc.) should be wide open to increased air flows and remove gas etc.

- Entry of manure pits should be avoided. If a manure pit is entered with even a small quantity of manure present, the person should be equipped with a respirator, a harness and lifeline, and should be supervised by a second person prepared with an emergency plan
- The insertion of traps or closing devices into a pipeline can be useful to block the rise of harmful gases
- People should not smoke or use an naked flame near slurry pits, or in poorly ventilated areas with manure present.

---

## REFERENCES AND FURTHER READING

- ALB, 2000. Tränken für Rinder, Arbeitsblatt Landwirtschaftliches Bauwesen. ALB in Bayern e.V. 02.18.01. August 2000
- Andersson, M., Schaar, J., & Wiktorsson, H., 1984. Effects of drinking water flow rates and social rank on performance drinking behaviour of tied-up dairy cows. *Livest. Prod. Sci.*, 11, 599-610.
- Arnold, N.A., Ng, K.T., Jongman E. C. & Hemsworth, P.H., 2007. The behavioural and physiological responses of dairy heifers to tape-recorded milking facility noise with and without a pre-treatment adaptation phase. *Appl. Anim. Behav. Sci.*, 106 (1-3), 13-25.
- ASABE, 2007. Terminology and Recommendations for Freestall Dairy Housing. Freestalls, Feed Bunks, and Feeding Fences. ASAE EP444.1 DEC 1999(R2005). ASABE Standards [www.asabe.org](http://www.asabe.org)
- Baeta F.C., Meador N.F., Shanklin M.D. & Johnson H.D., 1987. Equivalent Temperature Index above the thermoneutral for lactating dairy cows, ASAE, Paper 87-4015, *Proc. Am. Soc. Agric. Eng.*, St. Joseph, Michigan.
- Bickert, W. G., Holmes, B., Janni, K., Kammel, D., Stowell, R. & Zulovich, J., 2000. Dairy freestall, housing and equipment. MWPS-7. Midwest Plan Service, Ames, Iowa
- Borg, R., 1994. Corrals for Handling Beef Cattle. Alberta Agriculture, Food and Rural Development, Edmonton, Alberta, Canada. 91 p.
- Boxberger, J. & Zips, A., 1979. Untersuchungen zur Trinkwasseraufnahme von Milchkühen im Laufstall. *Landtechnik*, 7/8, 361-364
- Cargill, C., Murphy, T., & Banhazi, T., 2002. Hygiene and air quality in intensive housing facilities in Australia. In: *Animal Production in Australia*, 387-393. D. K. Revell and D. Taplin, eds. Adelaide, South Australia: Australian Society of Animal Production.
- Castle, M. E., & Thomas, T.P., 1975. The water intake of British Friesian cows on rations containing various forages. *Animal Production*, 20, 181-189.
- CIGR, 2002. Climatization of Animal Houses. Report of the CIGR Section II, Working Group No. 4. Horsens, Denmark. [www.agrsci.dk/jbt/spe/CIGRreport](http://www.agrsci.dk/jbt/spe/CIGRreport).
- CIGR, 2004. Design Recommendations of Beef Cattle Housing. Report of the CIGR Section II, Working Group No. 14 Cattle Housing 2nd edition, September 2004. Gumpenstein, Austria
- Engle, R. & Graves, R.E., 2007. Guidelines for facilities for special needs animals. The dairy practices council, Publication No DPC 88. Keyport, New York state, USA.
- Grandin, T., 1999. Understanding Flight Zone and Point of Balance. [www.com/behaviour/principles/flight.zone.html](http://www.com/behaviour/principles/flight.zone.html)
- Graves, R.E., Engle, R. & Tyson, J.T., 2006. Design information for housing special dairy cows. *Proc. In 2006 ASABE (American Society of Agricultural and Biological Engineers) Annual International Meeting, Portland, Oregon 9 - 12 July 2006. Paper No 064034.*

- Graves, Robert E. et al., 2009. Guideline for Planning Dairy Freestall Barns. DPC 1. Dairy Practices Council <http://www.dairypc.org>
- Graves, R. E., 2006, 2008. Penn State Housing Plans for Milking and Special-Needs Cows. NRAES 200, 201. Also at Penn State Dairy Idea Plans 2014. <http://abe.psu.edu/extension/idea-plans>
- Hansen, P.J., 1985. Seasonal modulation of puberty and the postpartum anestrus in cattle: A review. *Livest. Prod. Sci.*, 12, 309.
- Harms J., Wendl G. & Schön H., 2002. Influence of cow traffic on milking and animal behaviour of robotic milking, in First North American Conference on Robotic Milking. March 20 - 22, 2002, Toronto, Canada
- Head, H. H. Kull, R. C., Jr. Campos, M. S. Bachman, K. C. Wilcox, C. J. Cline, L. L. & Hayen, M. J., (1993). Milk Yield, Milk Composition, and Behavior of Holstein Cows in Response to Jet Aircraft Noise Before Milking. *J. Dairy Sci.*, 76 (6), 1558-1567.
- Heffner, R. S. & Heffner, H. E., (1992). Hearing in large mammals: sound-localization acuity in cattle (*Bos taurus*) and goats (*Capra hircus*). *J. Comp. Psychol.*, 106 (2), 107-113.
- Himmel, U., 1964. Der Einfluss von temperiertem Trankwasser auf Milchmenge und 119 Fettgehalt bei Kühen. *Tierzucht*, 18, 133-136.
- Holmes, Brian et al., 2013 Dairy Freestall Housing and Equipment, eighth edition. MWPS-7. Ames Iowa USA [www.mwps.org](http://www.mwps.org)
- Hultgren J., Telezhenko E., Ventorp, M. & Bergsten C., 2009. Walkway floor design, feed stalls, claw lesions and locomotion in Swedish cubicle-housed dairy cattle. In: Sustainable animal production. The challenges and potential developments for professional farming, pp 121-133. Wageningen Academic Publishers, Wageningen.
- Kaufmann, R et al., 2001. Automatisches Melken - Systeme, Einsatzgrenzen, Wirtschaftlichkeit, FAT reports 579, Tänikon
- Lensink, B.J., Ofner-Schröck, E., Ventorp, M., Zappavigna, P., Flaba, J., Georg, H. & Bizeray-Filoché, D., 2013. Lying and walking surfaces for cattle, pigs and poultry and their impact on health, behaviour and performance In: Livestock housing - Modern management to ensure optimal health and welfare of farm animals, pp 75 - 92. Wageningen Academic Publishers, Wageningen.
- Magnusson M., Herlin A. & Ventorp, M., 2008. Short Communication: Effect of Alley Floor Cleanliness on Free-Stall and Udder Hygiene. *J. Dairy Sci.*, 91, 3927-3930
- Metzner, R., 1978. Trinkverhalten des Rindes-technisch richtig umsetzen. *Landtechnik*, 9, 386-390.
- Meyer, U., Everinghoff, M., Gadenken, D., & Flachowsky, G., 2004. Investigations on the water intake of lactating dairy cows. *Livest. Prod. Sci.*, 90, 117-121.
- Morton J.M., Tranter W.P., Mayer D.G. & Jonsson N.N., 2007. Effects of environmental heat on conception rates in lactating dairy cows: critical periods of exposure, *J. Dairy Sci.*, 90 (5), 2271-2278.
- MWPS (MidWest Plan Service), 2013. Dairy freestall housing and equipment. Holms, B. et. al. Iowa State University, 8<sup>th</sup> edition. Ames, Iowa, USA
- Nosal, D. & Bilgery, E., 2002. Welchen Einfluss hat der Lärm von Melkmaschinen? [online]. [www.bitec-melktechnik.ch/\\_downloads/Ufa\\_Revue\\_02\\_Melkmaschinen\\_ok.pdf](http://www.bitec-melktechnik.ch/_downloads/Ufa_Revue_02_Melkmaschinen_ok.pdf) [last access: 14.11.2011]
- Nosal D. & Schick M., 1995. Neue Melksysteme, FAT reports 475, Tänikon
- Ordolff D., 1992. Melkstandanlagen, KTBL working paper 1992. Freising, Germany
- Pinheiro M. F. et al, 2004. Designing better water troughs: Dairy cows prefer and drink more from larger troughs. *Appl. Animal Beh. Sci.*, 89, 185-193
- Schäffer, D., Marquardt, V.; Marx, G.; Von Borell, E. (2001): Lärm in der Nutztierhaltung- eine - Übersicht, unter besonderer Berücksichtigung der Schweinehaltung. *Deutsche Tierärztliche Wochenschrift*, 108, 60-66.
- Smith, J.F., Harner, J.P. & Brouk, M.J., 2001. Special Needs Facilities - Recommendations for housing pregnant, lactating and sick cows. Kansas State University, Manhattan, Kansas State, USA,
- Smith John F., 1996. Planning a Milking Center, Kansas State University Agricultural Experiment Station and Cooperative Extension Service
- Stefanowska, J., Smits, M. C. J., & Braam, C. R., 1998: Impact of floor surface on behaviour, locomotion and foot lesions in cattle. Report 98-09. 68 p. IMAG-DLO, Wageningen, The Netherlands.
- Telezhenko, E., & Bergsten, C. 2005. Influence of floor type on the locomotion of dairy cows. *App. Anim. Beh. Sci.*, 93, 183-197.
- Thune A., Berggren A., Gravas L. & Wiktorsson H., 2002. Barn layout and cow traffic to optimise the capacity of an automatic milking system, in First North American Conference on Robotic Milking. March 20 - 22, 2002. Toronto, Canada
- Tucker, C.B., Rogers, A.R., & Schutz, K.E., 2008. Effect of solar radiation on dairy cattle behaviour, use of shade and body temperature in a pasture-based system. *Appl. Anim. Behav. Sci.*, 109, 141-154.
- van der Tol, P.P.J., Metz, J.H.M., Noordhuizen-Stassen, E.N., Back, W., Braam, C.R. & Weijs, W.A., 2003. The vertical ground reaction force and the pressure distribution on the claws of dairy cows while walking on a flat substrate. *J. Dairy Sci.*, 86, 2875-2883.
- Waiblinger, S., Menke, C. & Fölsch, D.W., 2003. Influences on the avoidance and approach behaviour of dairy cows towards humans on 35 farms. *Appl. Anim. Behav. Sci.*, 84, 23-39.
- Waynert, D.F., Stookey, J.M., Schwartzkopf-Genswein, K.S., Watts, J.M., and Waltz, C.S., 1999. The responses of beef cattle to noise during handling. *Appl. Anim. Behav. Sci.*, 62, 27-42.
- WCED - World Commission on Environment and Development, 1987. Our common future. Oxford University Press, 416 p.
- Wolf, F.; Marten, J., (2002). Untersuchungen zum Stallwetter in Außenklimaställen für Milchkühe unter besonderer Berücksichtigung des Tierverhaltens. Forschungsbericht, Landesforschungsanstalt für Landwirtschaft und Fischerei. Mecklenburg-Vorpommern, Institut für Tierproduktion, Dummerdorf.